



Glass Passivated Three Phase Rectifier Bridge

VRRM 800 to 1800V
ID 250 A

Applications

- Three phase rectifiers for power supplies
- Rectifiers for DC motor field supplies
- Battery charger rectifiers
- Input rectifiers for variable frequency drives

Features

- Three phase bridge rectifier
- Blocking voltage:800 to 1800V
- Heat transfer through aluminum oxide DBC ceramic isolated metal baseplate
- Glass passivated chip
- UL recognized applied for file no. E360040

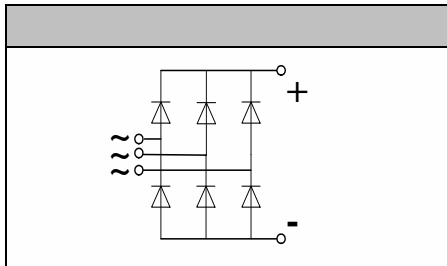

Module Type

| TYPE | VRRM | VRSM |
|------------|-------|-------|
| MD250S08M3 | 800V | 900V |
| MD250S12M3 | 1200V | 1300V |
| MD250S16M3 | 1600V | 1700V |
| MD250S18M3 | 1800V | 1900V |

Maximum Ratings

| Symbol | Conditions | Values | Units |
|------------------|-------------------------------|-------------|------------------|
| ID | Three phase, full wave Tc=100 | 250 | A |
| IFSM | t=10mS Tvj =45 | 2500 | A |
| i ² t | t=10mS Tvj =45 | 31250 | A ² s |
| Visol | a.c.50HZ;r.m.s.;1min | 3000 | V |
| Tvj | | -40 to +150 | |
| Tstg | | -40 to +125 | |
| Mt | To terminals (M6) | 5±15% | Nm |
| Ms | To heatsink (M6) | 5±15% | Nm |
| Weight | Module (Approximately) | 230 | g |

Thermal Characteristics

| Symbol | Conditions | Values | Units |
|----------|------------------------|--------|-------|
| Rth(j-c) | Per diode | 0.36 | /W |
| Rth(c-s) | Module (Approximately) | 0.02 | /W |

Electrical Characteristics

| Symbol | Conditions | Values | | | Units |
|--------|------------------|--------|------|------|-------|
| | | Min. | Typ. | Max. | |
| VFM | T=25 IF =300A | | 1.35 | 1.6 | V |
| IRD | Tvj=25 VRD=VRRM | | | 0.5 | mA |
| | Tvj=150 VRD=VRRM | | | 6 | mA |

Performance Curves

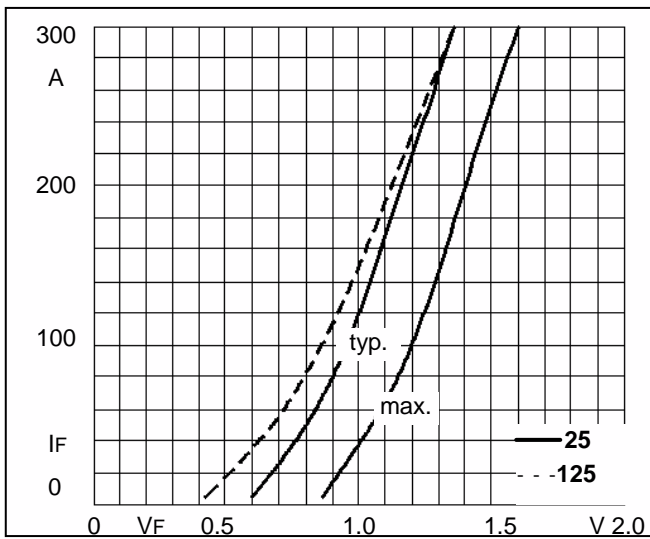

Fig1. Forward Characteristics

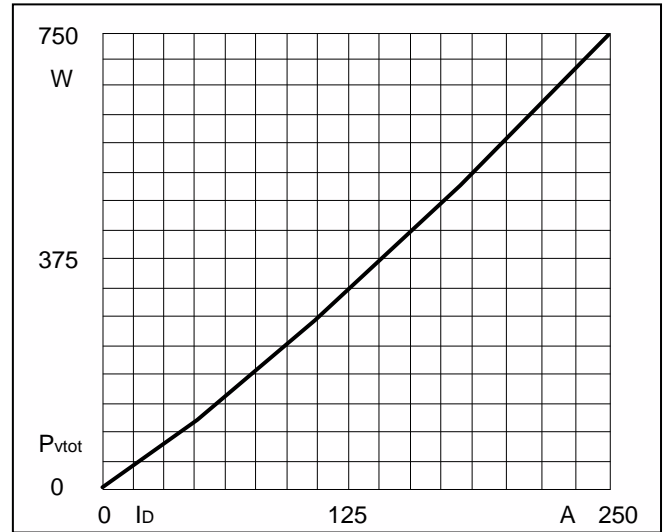

Fig2. Power dissipation

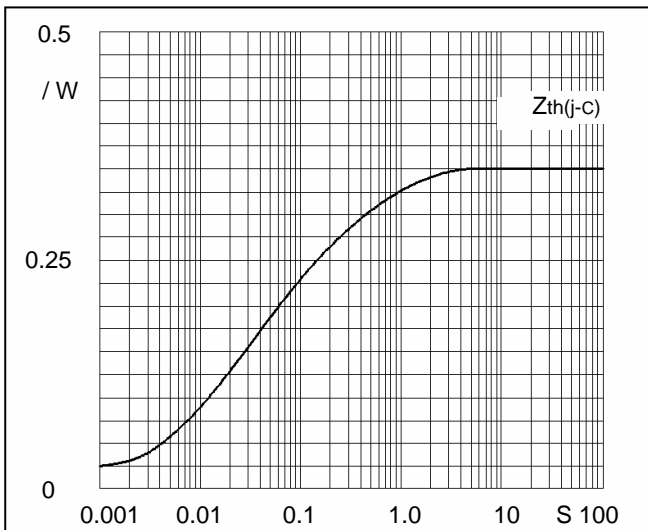

Fig3. Transient thermal impedance

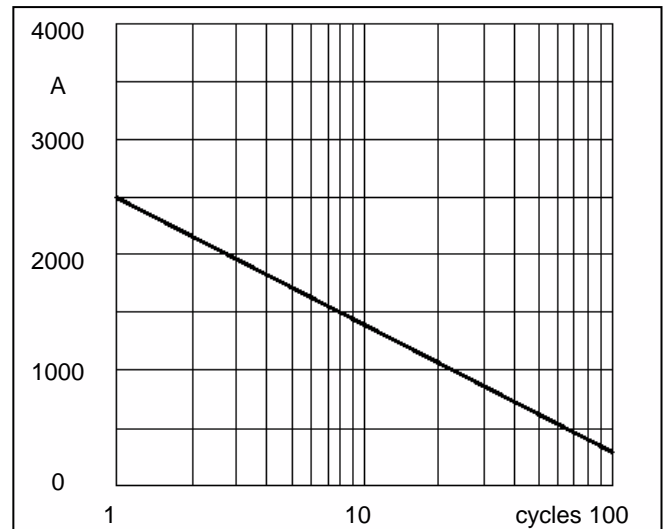

Fig4. Max Non-Repetitive Forward Surge Current

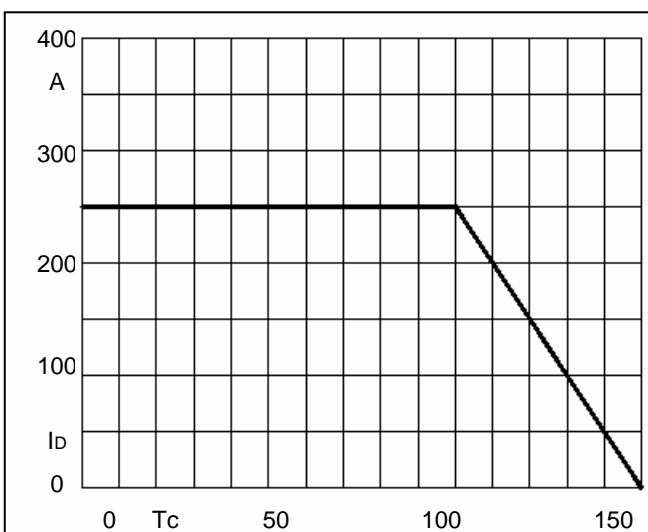
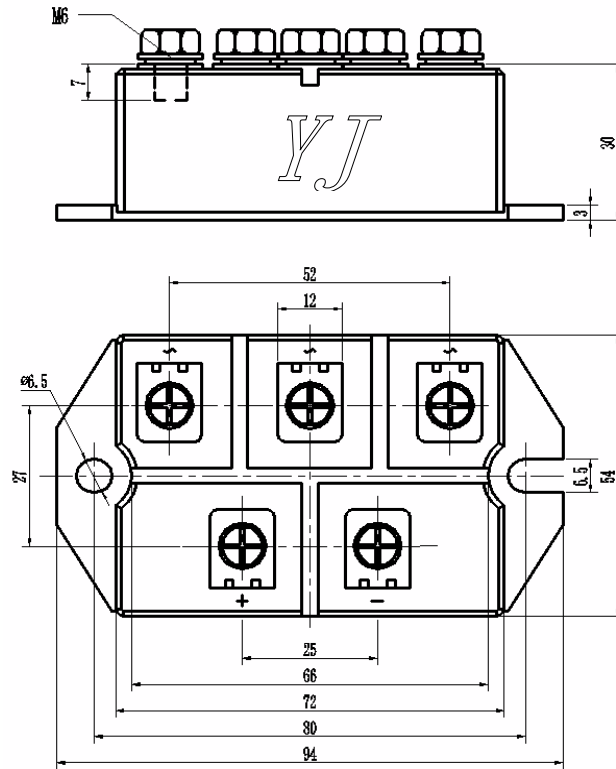

Fig5. Forward Current Derating Curve

Package Outline Information

CASE M3



Dimensions in mm