



TRX 特锐祥
专注电容器材料

	SMD- 1 SMD 1 . .		
	/N		/D
	/E		/P

SMI-
SMD

专注电

/P N

G 1 102 K





2. /P

B

Y1 102K 400V



 TRX 专注电容器廿年	SMD- 1 SMD 1 . .		
	/N		/D
	/E		/P

/E	
	
   	

3. /D

↓									
↓									
			↓						
			↓						

 TRX 专注电容器廿年	SMD- 1		
	SMD 1 . .		
	/N		/D
/E		/P	



6. /S
/

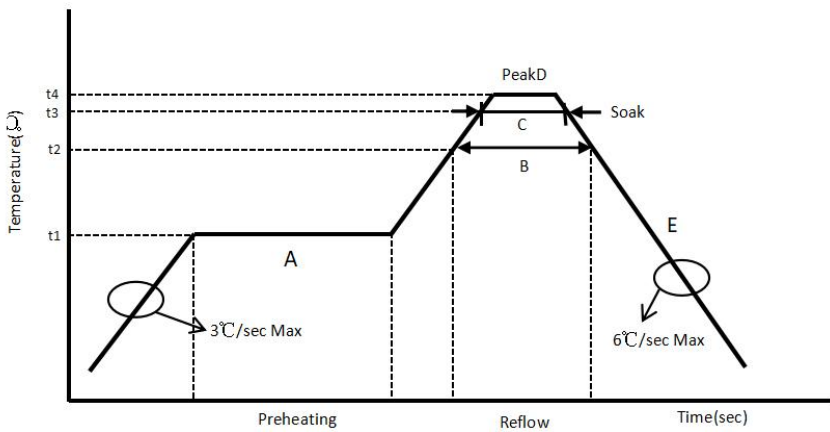

 TRX 专注电容器廿年	SMD- 1		
	SMD 1 . .		
	/N		/D
/E		/P	

/

/

7. /P



SMD- 1
SMD 1 . .

/N

/D

/E

/P

/N

/D

/E

/P

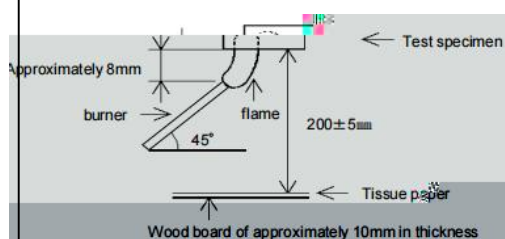

 TRX 专注电容器廿年	SMD- 1		
	SMD 1 . .		
	/N		/D
	/E		/P

8. /C

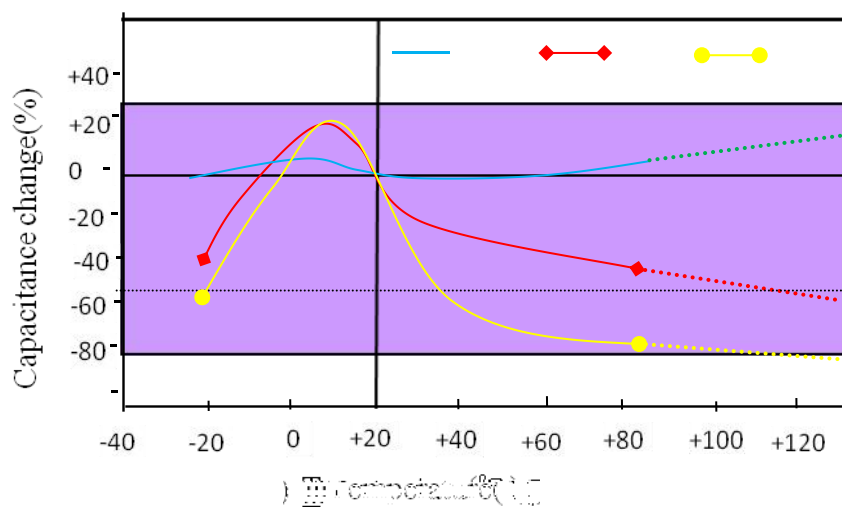

	SMD- 1			
	SMD 1 . .			
	/N		/D	
	/E		/P	

9.

/C

**R HS H.F.
REACH**

10.

/S

/

/



SMD- 1
SMD 1 . .

/N

/D

/E

/P

11. /P

/

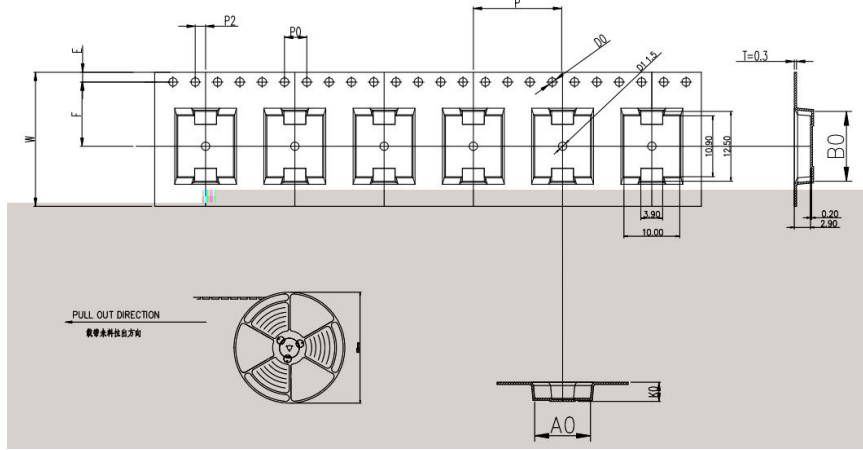

ITEM	W	A0	B0	K1	K0	P	F	E	D0	D1	P0	P2	T
DIM	24.0	$^{+0.30}_{-0.30}$	$^{+0.10}_{-0.10}$	$^{+0.10}_{-0.10}$	$^{+0.10}_{-0.10}$	$^{+0.10}_{-0.10}$	$^{+0.10}_{-0.10}$	$^{+0.10}_{-0.10}$	$^{+0.10}_{-0.00}$	$^{+0.10}_{-0.00}$	$^{+0.10}_{-0.10}$	$^{+0.10}_{-0.10}$	$^{+0.05}_{-0.05}$
ALTERNATE													

/

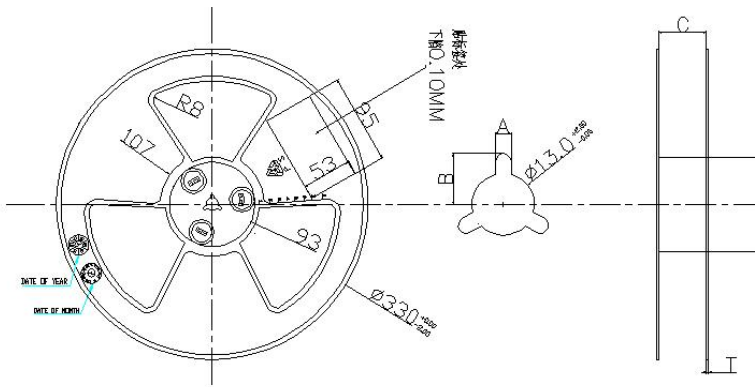

SPEC	A±0.3	B±0.5	C $^{+0.5}_{-0.0}$	D±0.5	T±0.2
24	2.3	10.75	24.4	Ø97	2.2

/

Item	Data	Remark
Cover tape adhesion	10 ~ 100g	Carrier tape and cover tape open angle 165 ~ 180° F=300± 5mm/minute

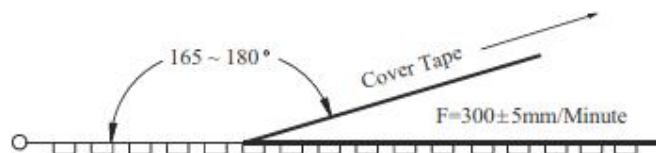

 TRX 专注电容器廿年	SMD- 1		
	SMD 1 . .		
	/N		/D
		/P	

/ -

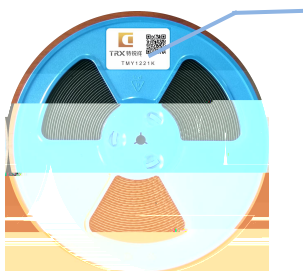



TRX 特锐祥
TGY1102K

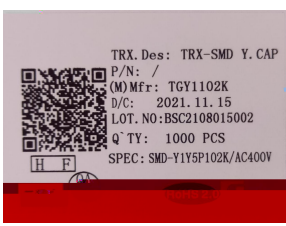

TRX Des: TRX-SMD Y. CAP
P/N: /
(M) Mfr: TGY1102K
D/C: 2021.11.15
LOT. NO: BSC2108015002
QTY: 1000 PCS
SPEC: SMD-Y115P102K/AC400V

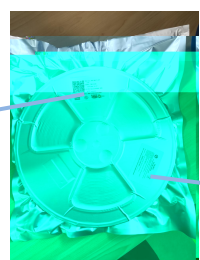

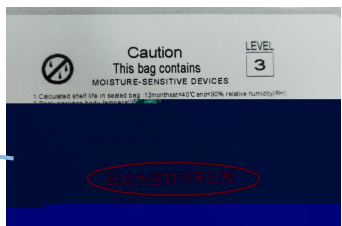

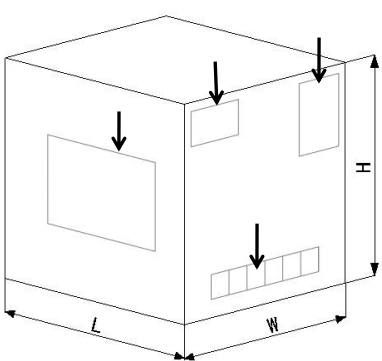

Caution
This bag contains
MOISTURE-SENSITIVE DEVICES
LEVEL 3

/O -







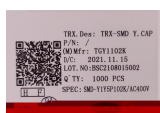

TRX Des: TRX-SMD Y. CAP
P/N: /
(M) Mfr: TGY1102K
D/C: 2021.11.15
LOT. NO: BSC2108015002
QTY: 1000 PCS
SPEC: SMD-Y115P102K/AC400V

/
/
/

/P :









/
/

R

