			iiiiii iiii F



TRX 特锐祥
专注电容器材料



SMD- 1
SMD 1 . .

/N

/D

/E

/P

/

I

/

II

TR SMD- 1.CAP
C R T.C D (U : F

T.C						

	SMD- 1 SMD 1 . .		
	/N		/D
	/E		/P

 TRX 专注电容器廿年	SMD- 1 SMD 1 . .		
	/N		/D
	/E		/P

1. /P N

T G _1 102 K

2. /P

	B Y1 102K 480V 

 TRX 专注电容器廿年	SMD- 1		
	SMD 1 . .		
	/N		/D
/E		/P	

4. /C

5. /P

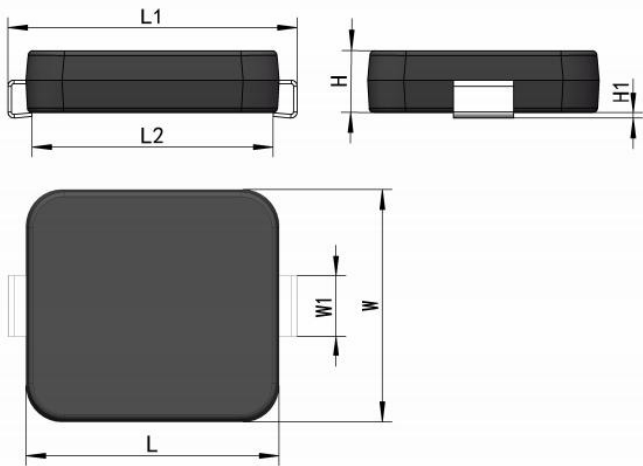

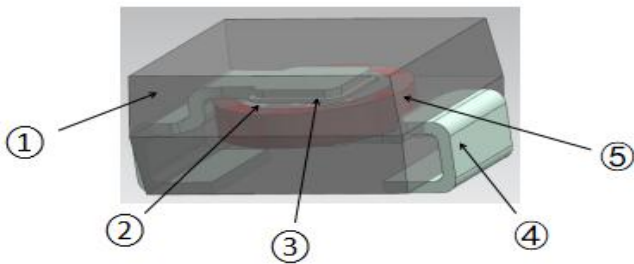



/N

SMD- 1
SMD 1 . .

 TRX 专注电容器廿年	SMD- 1		
	SMD 1 . .		
	/N		/D
/E		/P	

/

/

7. /P

 TRX 专注电容器廿年	SMD- 1		
	SMD 1 . .		
	/N		/D
/E		/P	

 TRX 专注电容器廿年	SMD- 1 SMD 1 . .		
	/N		/D
	/E		/P

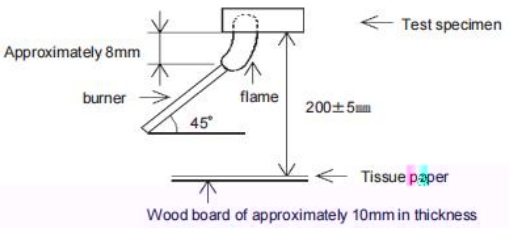
)
			 <p>Approximately 8mm</p> <p>burner</p> <p>45°</p> <p>flame</p> <p>200±5mm</p> <p>Test specimen</p> <p>Tissue paper</p> <p>Wood board of approximately 10mm in thickness</p>

 TRX 专注电容器廿年	SMD- 1		
	SMD 1 . .		
	/N		/D
	/E		/P

8. /C

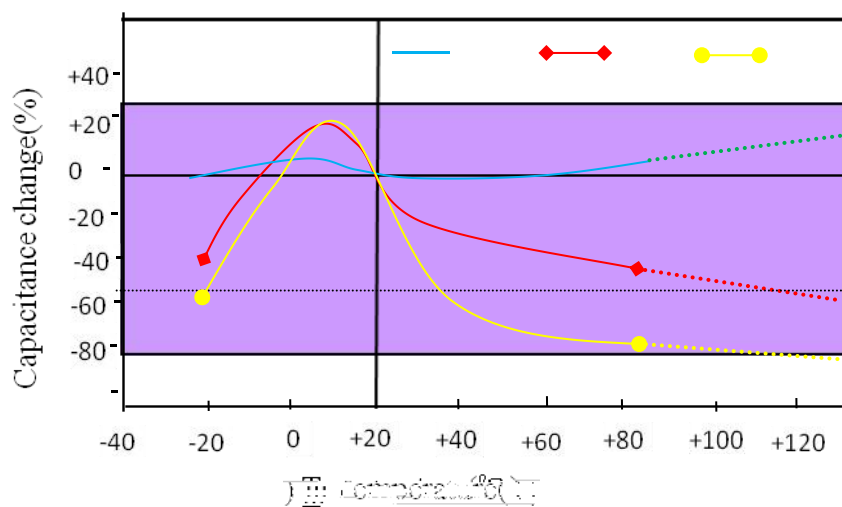



SMD- 1
SMD 1 . .

/N

/D

/E

/P

9.

/C

R HS H.F.
REACH

10.

/S

/

11. /P

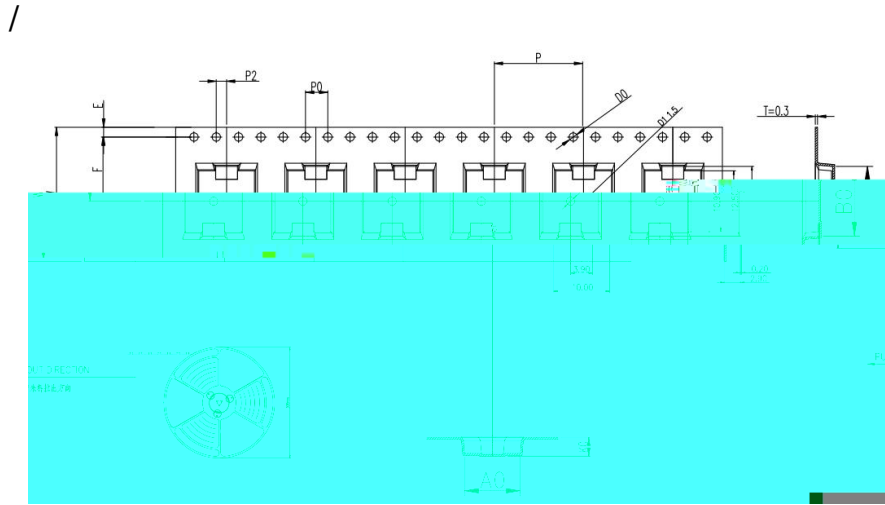

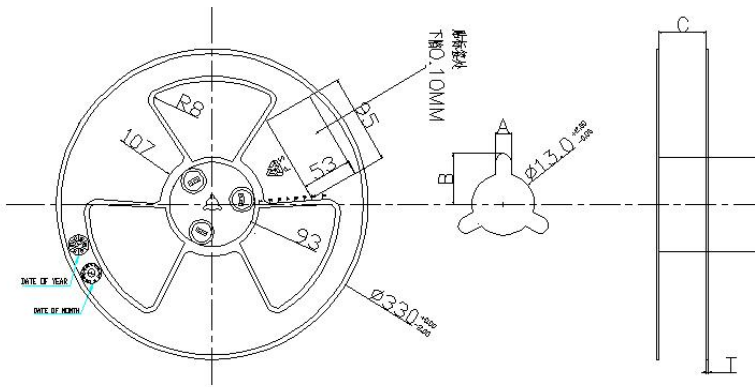

ITEM	W	A0	B0	K1	K0	P	F	E	D0	D1	P0	P2	T
DIM	24.0	$\begin{smallmatrix} +0.30 \\ -0.30 \end{smallmatrix}$	$\begin{smallmatrix} +0.10 \\ -0.10 \end{smallmatrix}$	$\begin{smallmatrix} +0.10 \\ -0.10 \end{smallmatrix}$	3.45	$\begin{smallmatrix} +0.10 \\ -0.10 \end{smallmatrix}$	$\begin{smallmatrix} +0.10 \\ -0.10 \end{smallmatrix}$	$\begin{smallmatrix} +0.10 \\ -0.10 \end{smallmatrix}$	$\begin{smallmatrix} +0.10 \\ -0.00 \end{smallmatrix}$	$\begin{smallmatrix} +0.10 \\ -0.00 \end{smallmatrix}$	$\begin{smallmatrix} +0.10 \\ -0.10 \end{smallmatrix}$	$\begin{smallmatrix} +0.10 \\ -0.10 \end{smallmatrix}$	$\begin{smallmatrix} +0.05 \\ -0.05 \end{smallmatrix}$

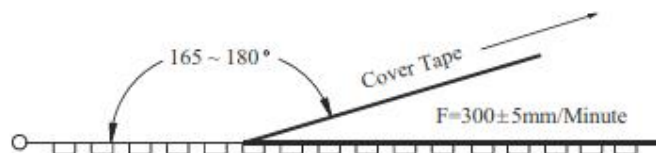

SPEC	A±0.3	B±0.5	C $\begin{smallmatrix} +0.5 \\ -0.0 \end{smallmatrix}$	D±0.5	T±0.2
24	2.3	10.75	24.4	Ø97	2.2

Item	Data	Remark
Cover tape adhesion	10 ~ 100g	Carrier tape and cover tape open angle 165 ~ 180° F=300± 5mm/minute



 TRX 专注电容器廿年	SMD- 1		
	SMD 1 . .		
	/N		/D
		/P	

/ -





TRX 特锐祥
TGY1102K





TRX Des: TRX-SMD Y. CAP
P/N: /
QMfr: TGY1102K
D/C: 2021.11.15
LOT. NO: BSC2108015002
QTY: 1000 PCS
SPEC: SMD-Y1YSP102K/AC400V





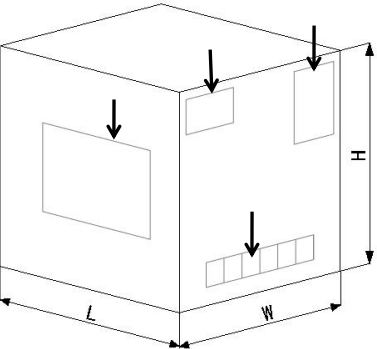

/O -











/
/
/

/P :







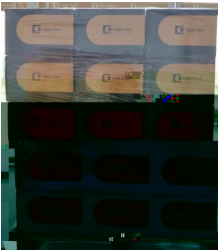

/
/

R

