



深圳市弗瑞鑫电子有限公司

规格承认书

—
——
——

prepare	
check	
approve	



TRX电容一级代理商

深圳市弗瑞鑫电子有限公司

Add:深圳市宝安区西乡大道302号金源商务大厦B座3楼

Tel:0755-29563634

Fax:0755-27447020

SMD- 2

SMD 2 . .

/N

/D

/E

/P

	SMD- 2 SMD 2 . .		
	/N		/D
	/E		/P

	SMD- 2 SMD 2 . .		
	/N		/D
	/E		/P

1. /P N

T B 2 102 M E
 ① ② ③ ④ ⑤ ⑥

①

 TRX 专注电容器廿年	SMD- 2 SMD 2 . .		
	/N		/D
	/E		/P

3. /D



 TRX 专注电容器廿年	SMD- 2 SMD 2 . .		
	/N		/D
	/E		/P

4. /C

5. /P

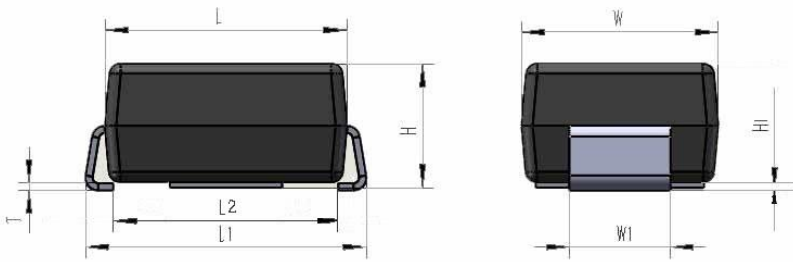

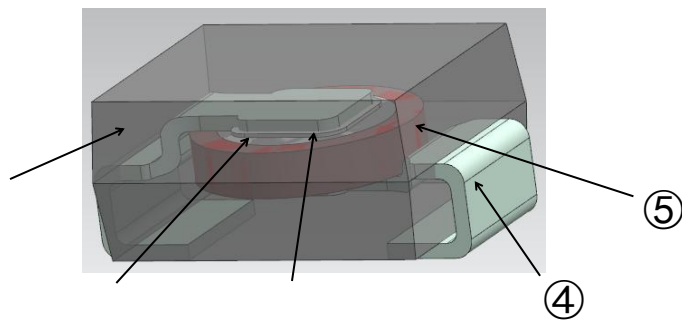

①		
②		
③		
④		
⑤		

SMD- 2
SMD 2 . .

/N

/D

/E

 TRX 专注电容器廿年	SMD- 2		
	SMD 2 . .		
	/N		/D
/E		/P	

/

°
°C

°

°

°

/

7. /P

	SMD- 2 SMD 2 . .		
	/N		/D
	/E		/P





SMD- 2
SMD 2 . .

/N

/D

/E

/P

					±
		±			
		±			
		±			
		±			

SMD- 2
SMDS

SMD- 2
SMD 2 . .





/N

/D

/E

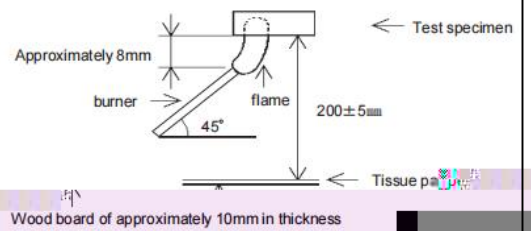
/P



 TRX 专注电容器廿年	SMD- 2 SMD 2 . .		
	/N		/D
	/E		/P

			± ±
			± ±
			± ±
			± ±
			± ±
			± ±
			± ±
			± ±
			± ±

8. /C

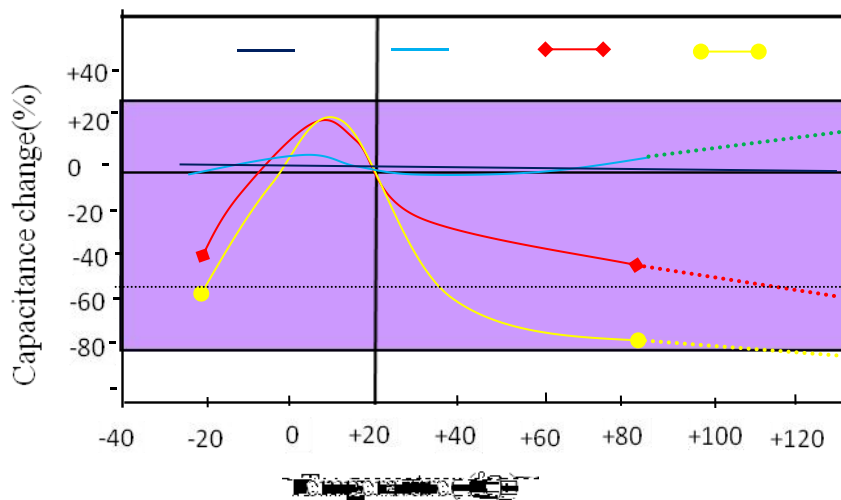

 TRX 专注电容器廿年	SMD- 2		
	SMD 2 . .		
	/N		/D
	/E		/P

11. /P P
/

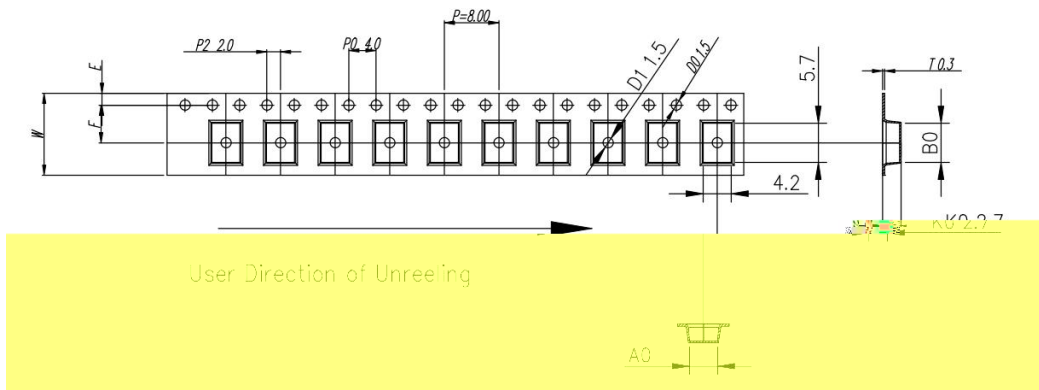

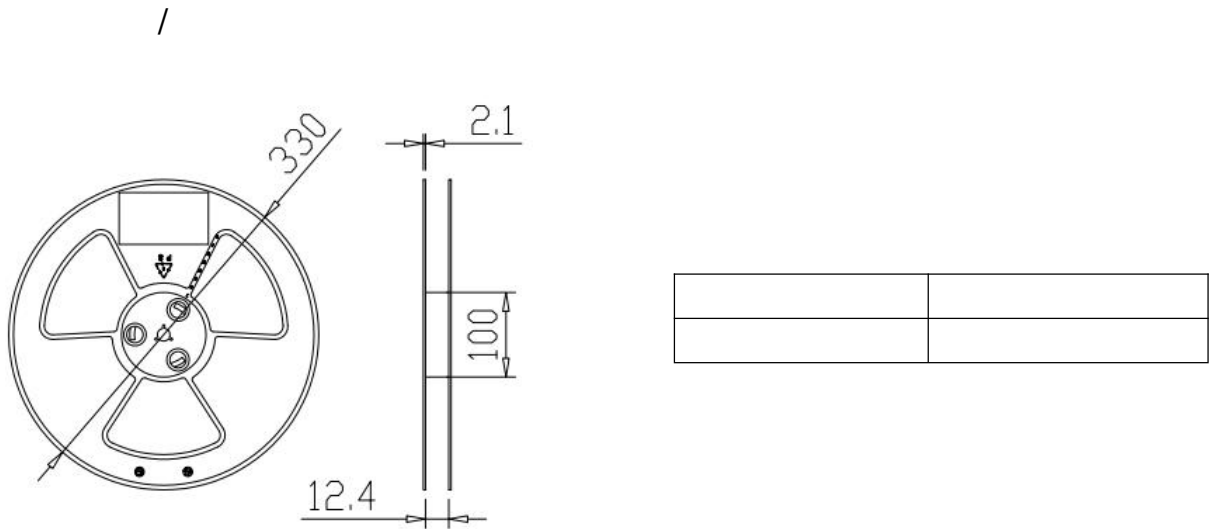

ITEM	W	A0	B0	K1	K0	P	F	E	D0	D1	P0	P2	T
DIM	12.0 ±0.30	4.2 ±0.10	5.70 ±0.10	--	2.70 ±0.10	8.00 ±0.10	5.50 ±0.10	1.75 ±0.10	1.5 ±0.00	1.5 ±0.10	4.0 ±0.10	2.0 ±0.10	0.30 ±0.05
ALTERNATE													

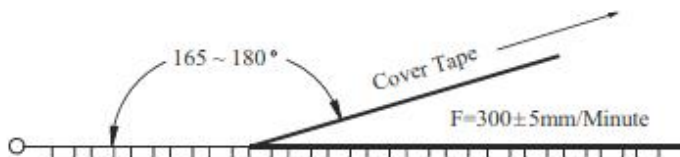

/

Item	Data	Remark
Cover tape adhesion	10 ~ 100g	Carrier tape and cover tape open angle 165 ~ 180° F=300±5mm/minute



 TRX 专注电容器廿年	SMD- 2 SMD 2 . .		
	/N		/D
	/E		/P

/ -

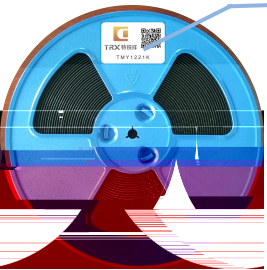

标签



料号

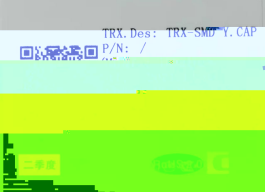



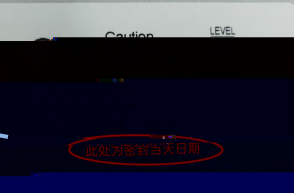

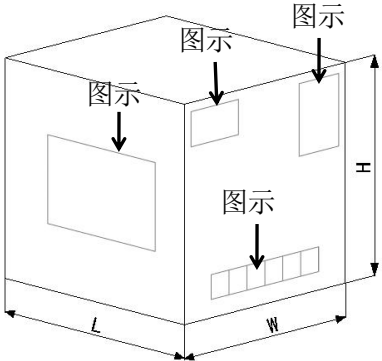

/O -





图示 / 图示 / 图示 /



/P :



/



/





" "

R

	SMD- 2 SMD 2 . .		
	/N		/D
	/E		/P

12. /A

①

②