

## 规格承认书

—

\_\_\_\_\_

\_\_\_\_\_

prepare	
check	
approve	



**TRX电容一级代理商**  
**深圳市弗瑞鑫电子有限公司**

Add: 深圳市宝安区西乡大道302号金源商务大厦B座3楼

Tel: 0755-29563634

Fax: 0755-27447020

**/ attached sheet I**

**/ attached sheet II**

**TRX      SMD-Y1.CAP**  
**Capacitance Range and T.C Differentiation      Unit:pF**

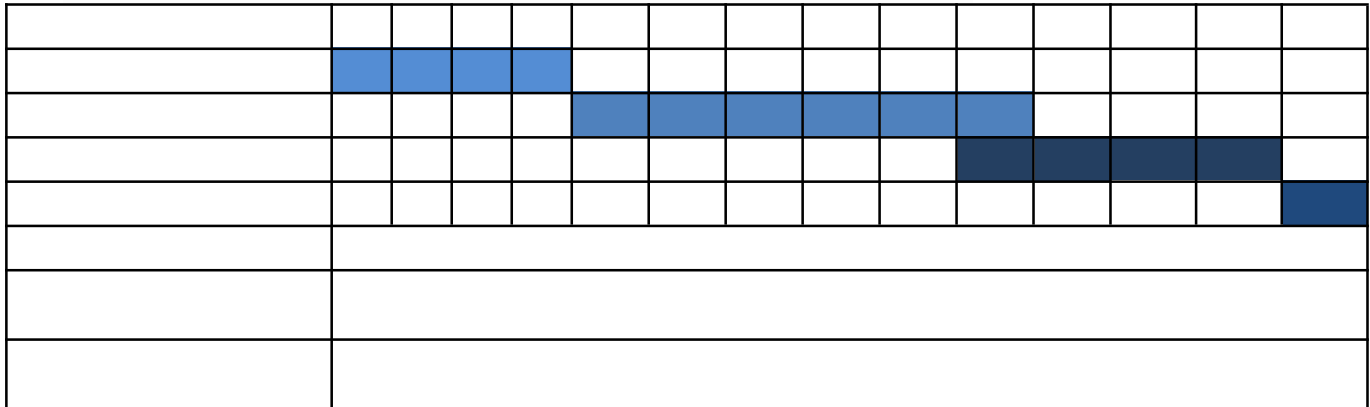

 <b>TRX</b> 专注电容器廿年	<b>SMD Y</b> <b>SMD Y1 a.c. ceramic capacitors</b>			
	/Number		/Date	
	/Edition		/Page	

 <p><b>TRX</b> 专注电容器廿年</p>	<b>SMD Y</b> <b>SMD Y1 a.c. ceramic capacitors</b>		
	/Number		/Date
	/Edition		/Page

**1. /Product Name**



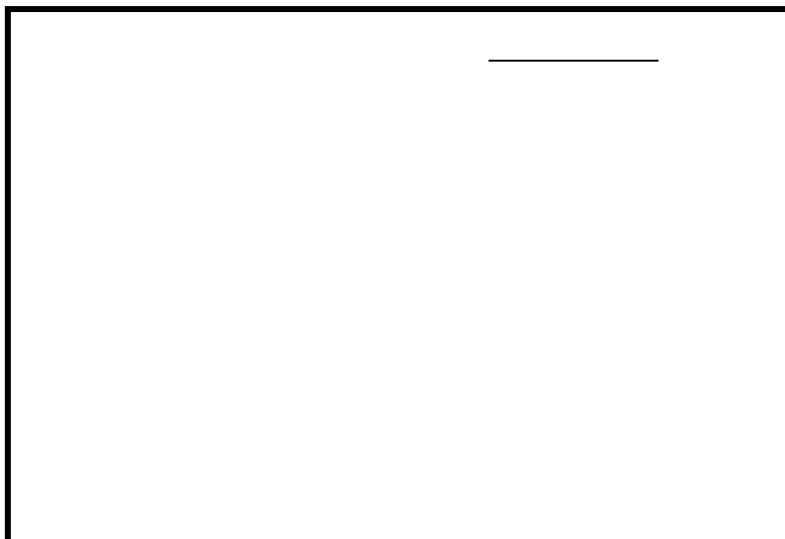
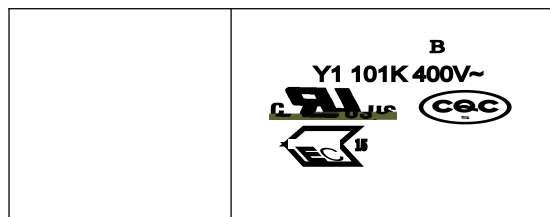

T   M   Y1   101   K  
 ①   ②   ③   ④   ⑤

①		
②		
③		
④		
⑤		

**2. /Product marking**



 <b>TRX</b> 专注电容器廿年	<b>SMD Y</b>		
	<b>SMD Y1 a.c. ceramic capacitors</b>		
	/Number		/Date
/Edition		/Page	

/Explanation	
	
	
	
	
	

3. /Date code

↓	↓				
		↓	↓		

**4. /Certificates**

certificates			

**5. / Product structure**

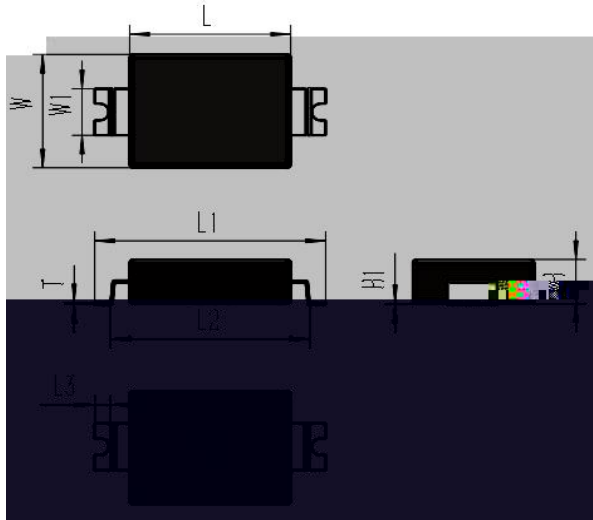

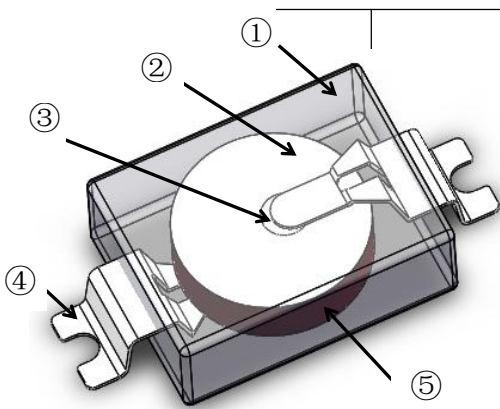
(4)		
(5)		



**SMD Y**  
**SMD Y1 a.c. ceramic capacitors**

/Number

/Date

/Edition

/Page

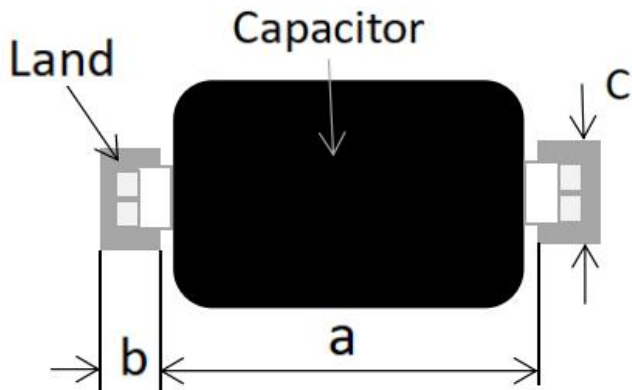



**6. /Soldering condition**

/

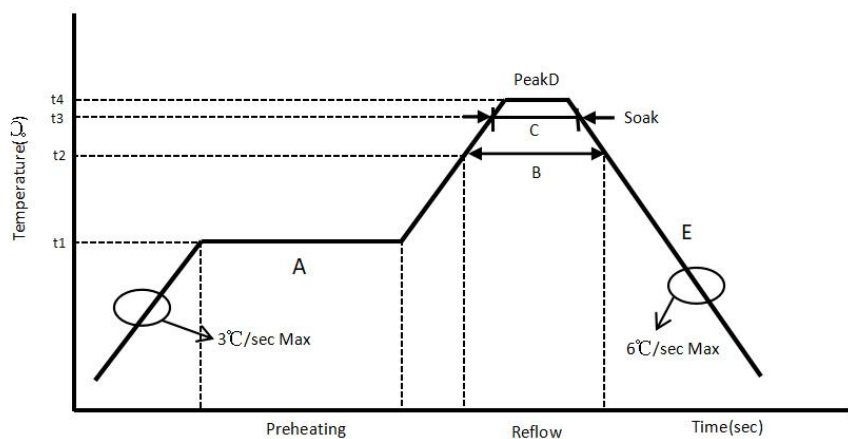
- °
- ° C
- °
- °



	<b>SMD Y</b> <b>SMD Y1 a.c. ceramic capacitors</b>		
	/Number		/Date
	/Edition		/Page

/

°  
°C  
°  
°  
°

/

**7. / Performance and test methods**



 <b>TRX</b> 专注电容器廿年	<b>SMD Y</b> <b>SMD Y1 a.c. ceramic capacitors</b>			
	/Number		/Date	
	/Edition		/Page	







SMD Y  
SMD Y1 a.c. ceramic capacitors

/Number

/Date

/Edition

/Page

		△	
		△	
		△	
		△	
		△	
		△	
		△	
		△	
		△	
		△	

**SMD Y**  
**SMD Y1 a.c. ceramic capacitors**





/Number

/Date

/Edition

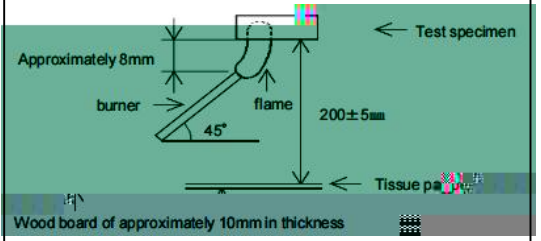
/Page



 <b>TRX</b> 专注电容器廿年	<b>SMD Y</b> <b>SMD Y1 a.c. ceramic capacitors</b>			
	/Number		/Date	
	/Edition		/Page	



	<b>SMD Y</b> <b>SMD Y1 a.c. ceramic capacitors</b>		
	/Number		/Date
	/Edition		/Page

**9. /Content of toxic and harmful substances control requirements**

**RoHS H.F.**  
**REACH**

**10. /Storage conditions**

(1)

(2)

/

/

(3)

(4)

**SMD Y**  
**SMD Y1 a.c. ceramic capacitors**



/Number		/Date	
/Edition		/Page	

11. /Prodn

r

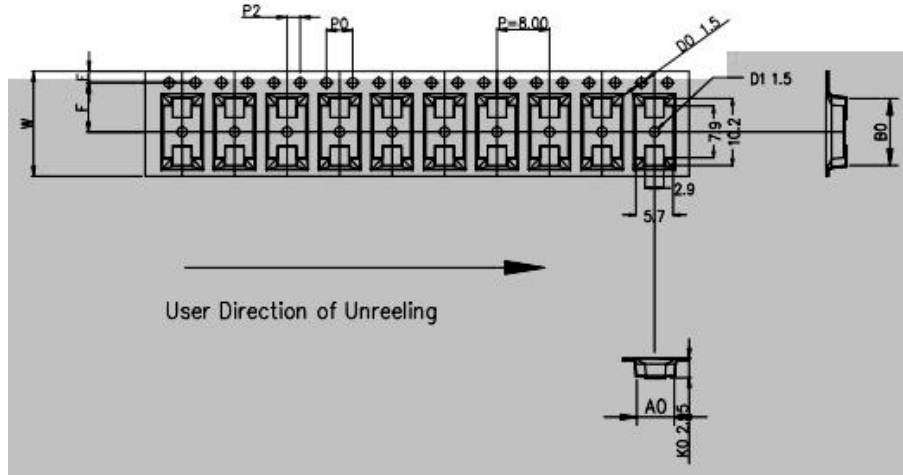

ITEM	$\Delta$ W	A0	B0	K1	K0	P	F	E	D0	D1	P0	P2	T
DIM	16.0 +0.30 -0.10	5.70 +0.10 -0.10	10.20 +0.10 -0.10	---	2.95 +0.10 -0.10	8.00 +0.10 -0.10	7.50 +0.10 -0.10	1.75 +0.10 -0.10	1.5	1.5 +0.10 -0.10	4.0 +0.10 -0.10	2.0 +0.10 -0.10	1.5
ALTERNATE													

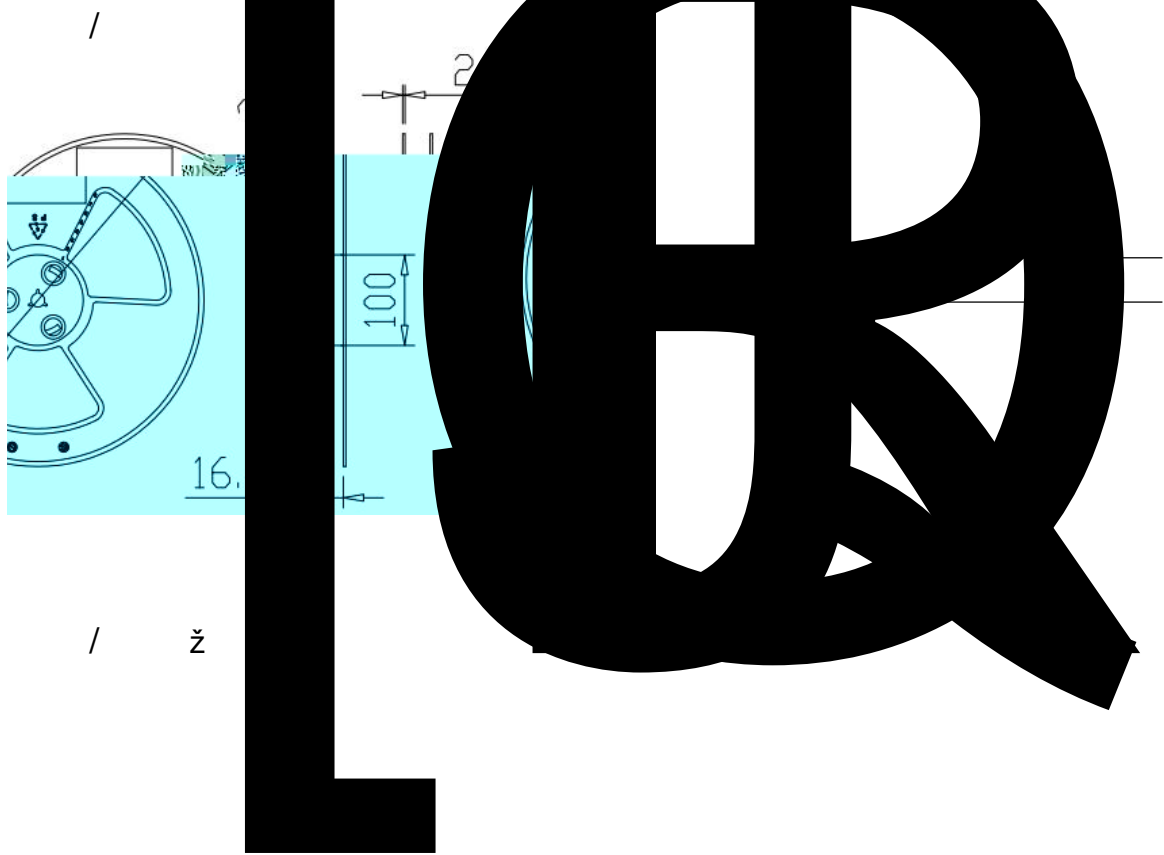

/ ž

 <b>TRX</b> 专注电容器廿年	<b>SMD Y</b>		
	<b>SMD Y1 a.c. ceramic capacitors</b>		
	/Number		/Date
	/Edition		/Page

**/inner-packaging**

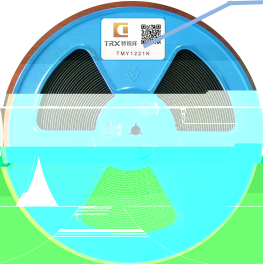



标签

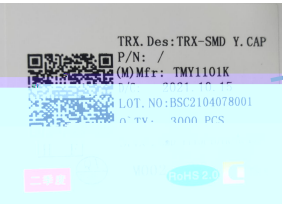

料号





**/Outer-packaging**





图示 /



图示 /



图示 /



**/Package sketch:**



/



/





**Remark**



	<b>SMD Y</b> <b>SMD Y1 a.c. ceramic capacitors</b>			
	/Number		/Date	
	/Edition		/Page	

**12. /Application notes**

①

②

③

④

⑤

⑥