



# 规格承认书

S

\_\_\_\_\_

\_\_\_\_\_

\_\_\_\_\_

\_\_\_\_\_

<b>JAENS</b>	
<b>SUNN</b>	



**TRX 特锐祥**  
专注电容器廿年

**TRX 电容器一级代理商**

深圳市弗瑞鑫电子有限公司

Add : 深圳市宝安区西乡大道302号华丰金源商务大厦B座3楼

Tel : 0755-29563634

Emial : sales@frxelec.com

 <b>TRX</b> 专注电容器廿年	<b>SMD Y2 a.c. ceramic capacitors</b>			
	/Number	- -0 2	/Date	2020-02-10
	/Edition	0	/Page	2 2

## /E.C.LIST

	- 2.		. .		
			0		2020-02-10
0	2020-02-10				
			/		

 <b>TRX</b> 专注电容器廿年	<b>SMD Y2 a.c. ceramic capacitors</b>			
	/Number	- 0 2	/Date	2020-02-10
	/Edition	0	/Page	2

/

	...	...		
1	/	2 1	- 2 1 / 00	0
2	/	2102	- 2 102 / 00	0
	/	2222	- 2 222 / 00	0
	/	2 2	- 2 2 / 00	0
	/	2 2	- 2 2 / 00	0
10				
11				
12				

2/ attached sheet II

**TRX SMD-Y1.CAP**

Capacitance Range and T.C Differentiation (Unit:pF)

1

1

T.C	0	1000	2200	00	00
2 ( )					
2 ( )					
2 ( )					
	00 .				
	- 0 12				
	0/ 12 / 21				

1000

100

..

1000 . ,

..

100 .

 <b>TRX</b> 专注电容器廿年	<b>SMD Y2 a.c. ceramic capacitors</b>			
	/Number	- -0 2	/Date	2020-02-10
	/Edition	0	/Page	2

/

1. -----
2. -----
- . -----
- . -----
- . -----
- . -----
- . -----
- . -----
- . -----
- . -----
10. -----
11. -----
12. -----

	<b>SMD Y2 a.c. ceramic capacitors</b>			
	/Number	- 0 2	/Date	2020-02-10
	/Edition	0	/Page	2

1. /Product Name

T   G   Y2   102   K   B  
 ①   ②   ③   ④   ⑤

.

①

②

③            2

④            102

 <b>TRX</b> 专注电容器廿年	<b>SMD Y2 a.c. ceramic capacitors</b>			
	/Number	- 0 2	/Date	2020-02-10
	/Edition	0	/Page	2

/Explanation	
	/ /
	- 2 - 2
	( ) / ( ) / ( )
102	( 0- 00 1- 2)
	/ ( 10%) / ( 20%)
1 0	1 1
2 00	2 2
0 12	

### 3. /Date code

		2020		1	01	1	01	1	1
		2021		2	02	2	02	1	1
2010		2022			0		0	1	1
2011		202			0		0	1	1
2012		202			0		0	20	20
201		202			0		0	21	21
201		202			0		0	22	22
201		202			0		0	2	2
201		202			0		0	2	2
201		202		10	10	10	10	2	2
201				11	11	11	11	2	2
201				12	12	12	12	2	2
						1	1	2	2
						1	1	2	2
						1	1	0	0
								1	1

**3. /Certificates**

certificates			
/	/ 0 -1	1 1	00 (. . .)
	/ .1 -201	200012 0 0	00 (. . .)
	0 -1 201 / 1 201	-0 1	00 (. . .)
	0 -1	0 0 -2100	2 0 (. . .)

**5. /Product structure**

.1 /

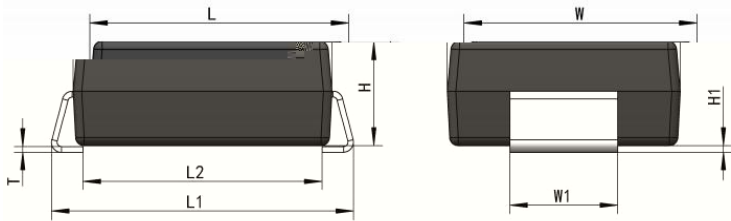

( )			
	.0 0.		. 0.
1	.0 0.	2	. 0.
	2. 0.1	1	2. 0.0
1	0.1 0.0		0.1 0.02

.2 /

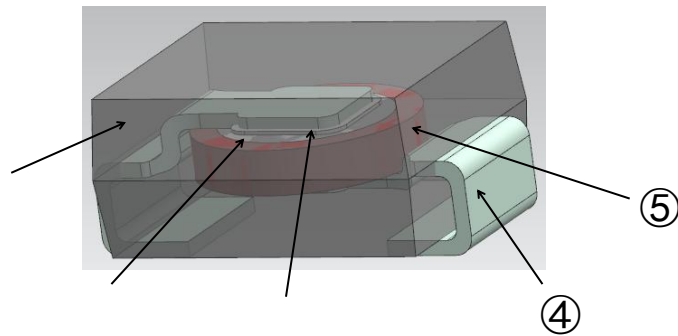

.		
①		( -0) ( -0)
②		
③		- - - -
④		
⑤		

 <b>TRX</b> 专注电容器廿年	<b>SMD Y2 a.c. ceramic capacitors</b>			
	/Number	- 0 2	/Date	2020-02-10
	/Edition	0	/Page	2

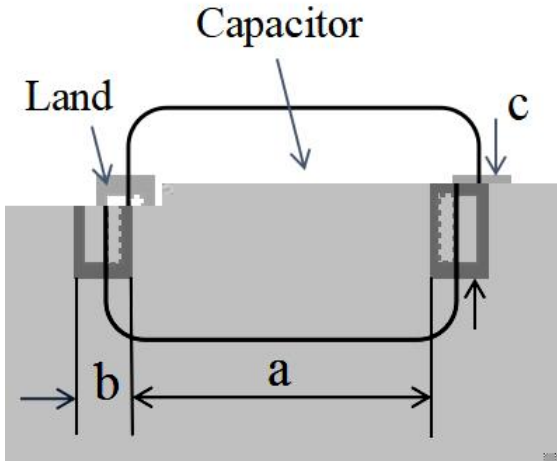

M

~~DIMS~~

~~DIMS~~

⊙

\

n<sup>0</sup>



 <b>TRX</b> 专注电容器廿年	<b>SMD Y2 a.c. ceramic capacitors</b>			
	/Number	- -0 2	/Date	2020-02-10
	/Edition	0	/Page	2

.2 /

2 0 °  
 2 0°C  
 0 °  
 0 °  
 200 °  
 200 °  
 1 0 °  
 1 0 °

. /

/

/ ,

00  
 - 00  
 0  
 0

**7. / Performance and test methods**

1			
2		.1 .1	



 <b>TRX</b> 专注电容器廿年	<b>SMD Y2 a.c. ceramic capacitors</b>			
	<b>/Number</b>	- -0 2	<b>/Date</b>	2020-02-10
	<b>/Edition</b>	0	<b>/Page</b>	11 2



 <b>TRX</b> 专注电容器廿年	<b>SMD Y2 a.c. ceramic capacitors</b>			
	/Number	- -0 2	/Date	2020-02-10
	/Edition	0	/Page	12 2



10 10

/ 0.

11

10%

1 %

1 %

2

2. %

2

, ,

/ 0 2

/ %

$\Delta (-0)/0$

/ 21

$\Delta 10\%$

$\Delta 1\%$

( 00 )

$\Delta 1\%$

( 00 )

12

( )

2

2 2

2 2 2

000

/ 12

/  $1000_{-0}^{+2}$

10 1.

1000

$\Delta (-0)/0$

0.1

$\Delta 10\%$

10 1.

$\Delta 1\%$

1000 . . . 0.1 .

$\Delta 1\%$

%

1

%.

2

2 2

000

2

2 2

 <b>TRX</b> 专注电容器廿年	<b>SMD Y2 a.c. ceramic capacitors</b>			
	/Number	- -0 2	/Date	2020-02-10
	/Edition	0	/Page	1 2



1

2

10

2

2

0

1

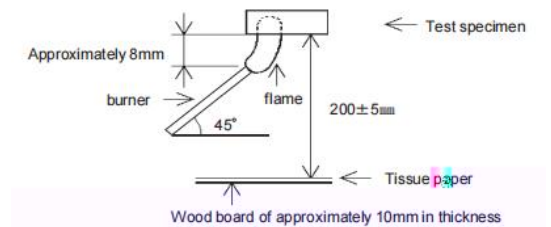



 <b>TRX</b> 专注电容器廿年	<b>SMD Y2 a.c. ceramic capacitors</b>			
	/Number	- -0 2	/Date	2020-02-10
	/Edition	0	/Page	1 2

**9. /Content of toxic and harmful substances control requirements**

2.0 2011/ /

1 0 /200



	( )
/	100
/	1000
/	1000
/	1000
/	1000
/	1000
+ + + / + + + + ( )	100
/	00
/	00
+ / +	1 00
( )	

**10. /Storage conditions**

(1).

(2).

(3).

(4).

( 0 1 )

( 0 1 )

## 11. /Product packaging

### 11.1 /

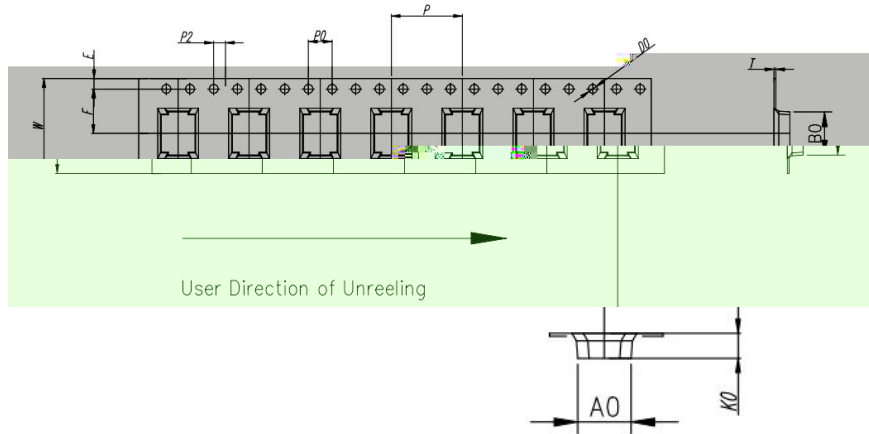

未标注斜角为: 5°.

ITEM	W	A0	B0	K1	K0	P	F	E	D0	D1	P0	P2	T
DIM	16.0 $\begin{smallmatrix} +0.30 \\ -0.30 \end{smallmatrix}$	5.70 $\begin{smallmatrix} +0.10 \\ -0.10 \end{smallmatrix}$	7.30 $\begin{smallmatrix} +0.10 \\ -0.10 \end{smallmatrix}$	---	2.70 $\begin{smallmatrix} +0.10 \\ -0.10 \end{smallmatrix}$	12.0 $\begin{smallmatrix} +0.10 \\ -0.10 \end{smallmatrix}$	7.50 $\begin{smallmatrix} +0.10 \\ -0.10 \end{smallmatrix}$	1.75 $\begin{smallmatrix} +0.10 \\ -0.10 \end{smallmatrix}$	1.5 $\begin{smallmatrix} +0.10 \\ -0.10 \end{smallmatrix}$	0.00 $\begin{smallmatrix} +0.10 \\ -0.10 \end{smallmatrix}$	4.0 $\begin{smallmatrix} +0.10 \\ -0.10 \end{smallmatrix}$	2.0 $\begin{smallmatrix} +0.10 \\ -0.10 \end{smallmatrix}$	0.30 $\begin{smallmatrix} +0.05 \\ -0.05 \end{smallmatrix}$
ALTERNATE													

### 11.2 /

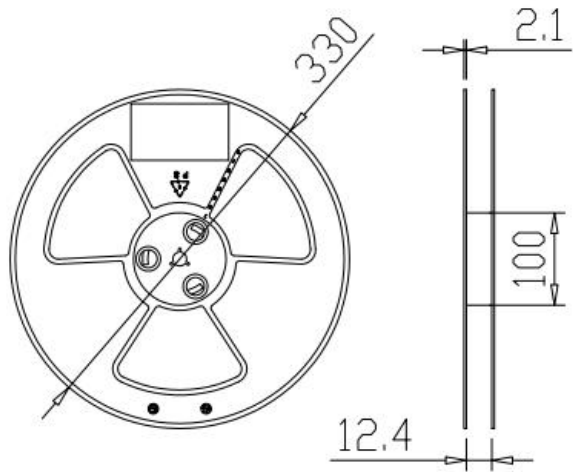

000	1
-----	---

### 11. /

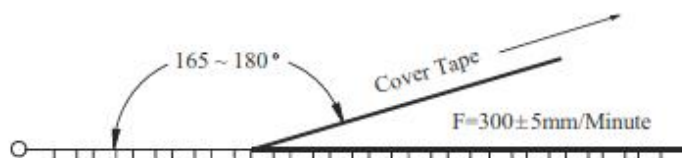

Item	Data	Remark
Cover tape adhesion	10 ~ 100g	Carrier tape and cover tape open angle 165 ~ 180° F=300± 5mm/minute







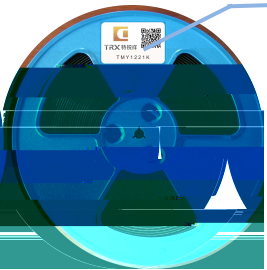

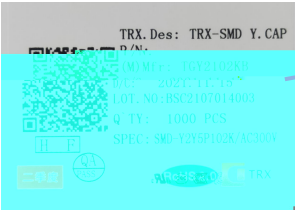
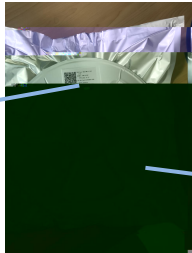
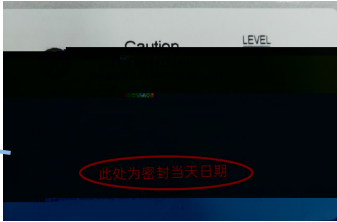

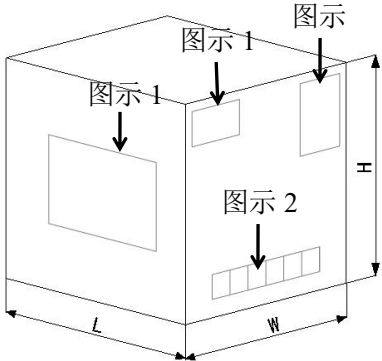
 <b>TRX</b> 专注电容器廿年	<b>SMD Y2 a.c. ceramic capacitors</b>			
	/Number	- -0 2	/Date	2020-02-10
	/Edition	0	/Page	1 2

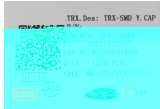
11. /

<b>/inner-packaging</b>			
 <p>标签/</p>	 <p>料号</p>		
/	1	/	
.0	/		
			
/	/	/	

<b>/Outer-packaging</b>			
			
图示 1/	1	图示 2/	2
		图示 /	
( )			
		2	1 .0

<b>/Package sketch:</b>			
			
/	1 / / 1 /	( / / ) ( / / )	( / / ) ( / / )
		1100*1100* 0	1100*1100*1 00

1.		2.	&
. 0	/		
<b>Remark 1.</b>		2.	& -
/	. 0		

	<b>SMD Y2 a.c. ceramic capacitors</b>			
	/Number	- -0 2	/Date	2020-02-10
	/Edition	0	/Page	1 2

**12. /Application notes**

①.

②.

( )

③.

④.

⑤.

⑥.