

Silicon Carbide Schottky Diode

	+))
(. .)	. . :
	++

Features

& 0

&

Typical Applications

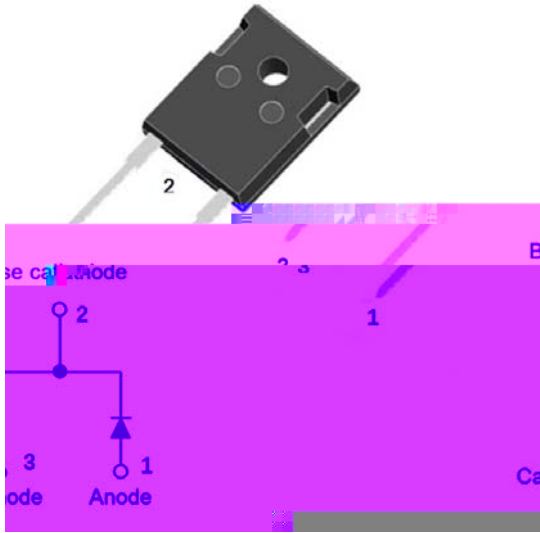

Mechanical Data

Package₃ &+ - 0 :

Terminals₃

Polarity₃:

Maximum Ratings + °C

PARAMETER	SYMBOL	UNIT	VALUE
			- +) .) @ @ .
9 +			+))
9 +			+))
9 + =			+))
9 +			0 . - - ()
& 9 +)			+))
= 9 +)			+ , -
9 +)			+ ,
			& 0



YJD112030NGG3

Electrical Characteristics

PARAMETER	SYMBOL	UNIT	TEST CONDITIONS	Typ.	Max.
			$V_F = 0$	-	0
			$V_F = 0$	+	
			$V_F = 0$		
			$V_F = 0$	0	
			$V_F = 0$	++	
			$V_F = 0$	0++	
			$V_F = 0$		
			$V_F = 0$		
			$V_F = 0$		
			$V_F = 0$	+	

Thermal Characteristics (+ °C)

PARAMETER	SYMBOL	UNIT	VALUE
			-

Characteristics

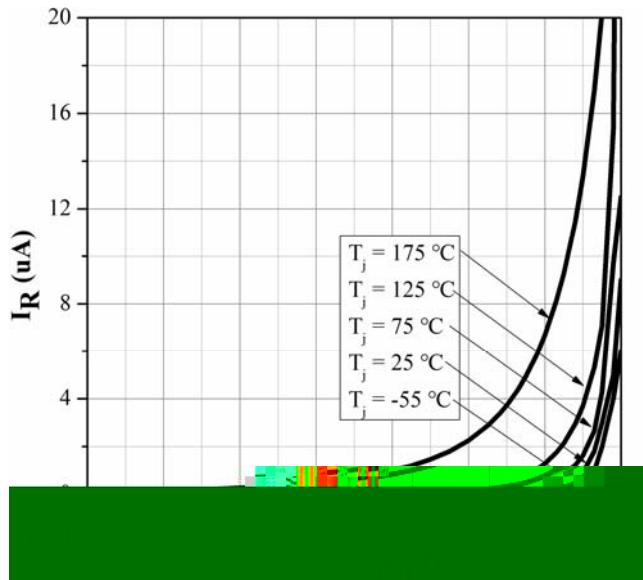
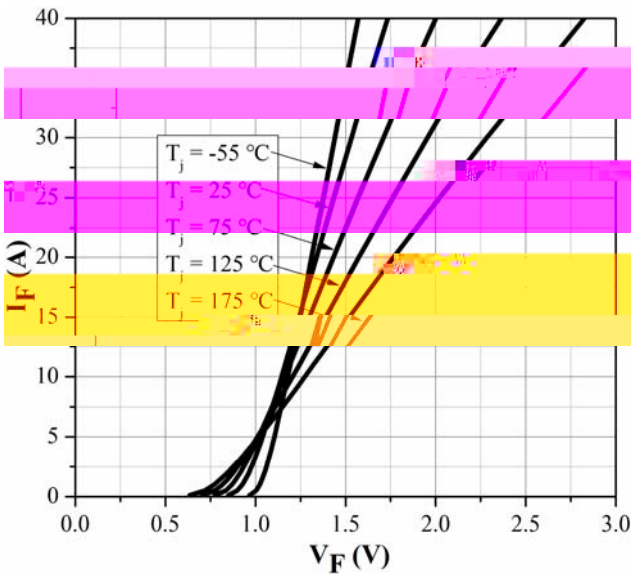



YJD112030NGG3

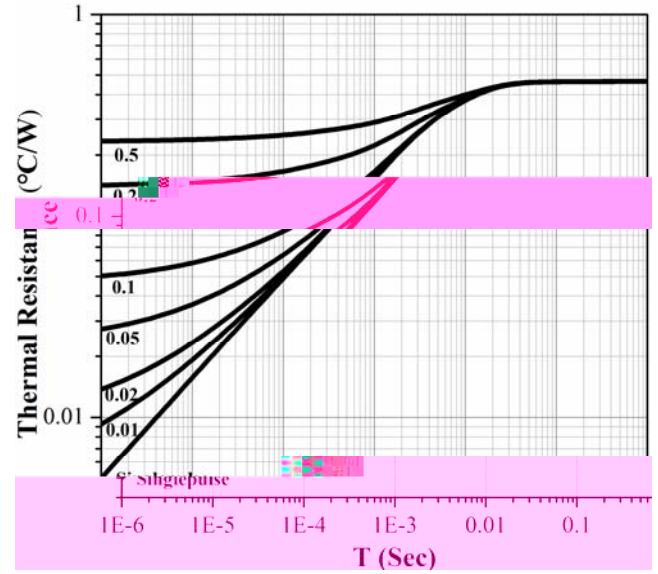
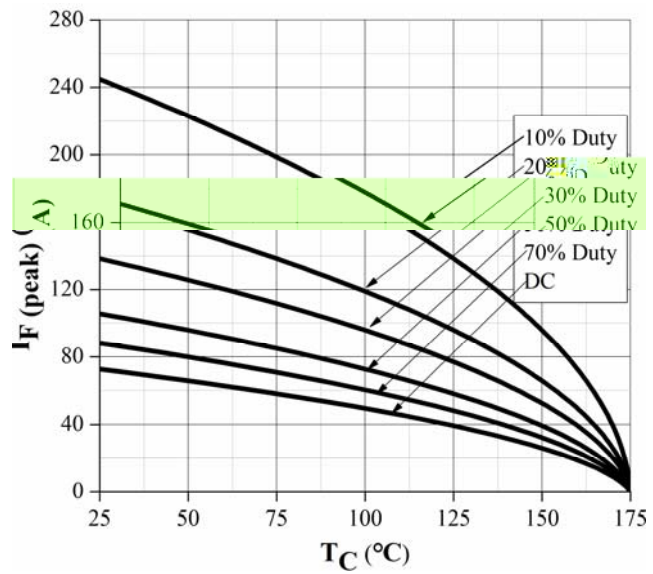
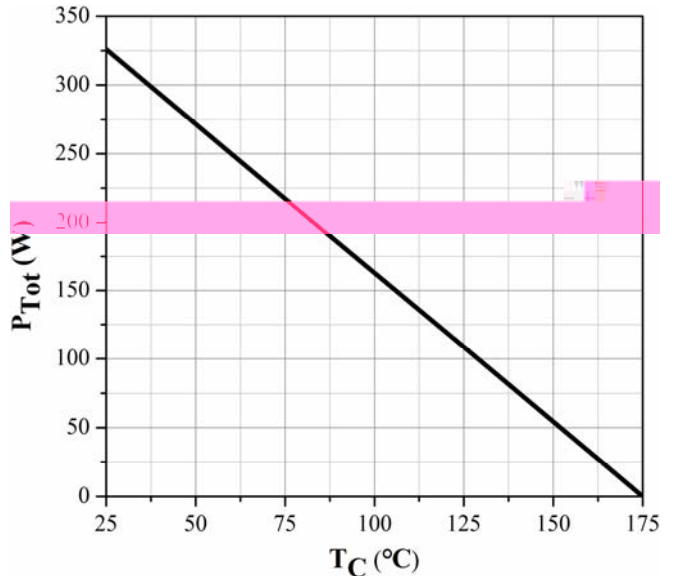
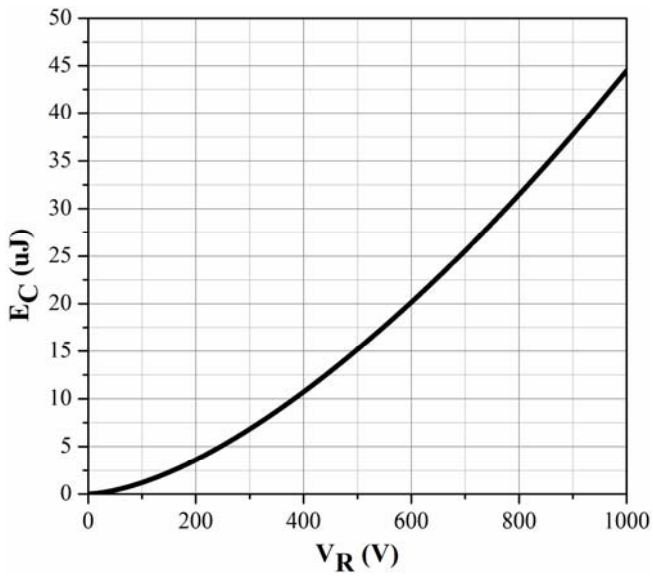
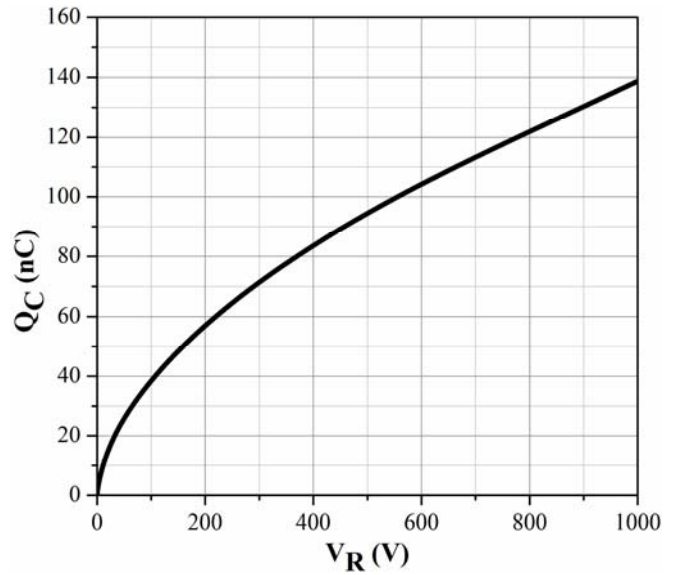
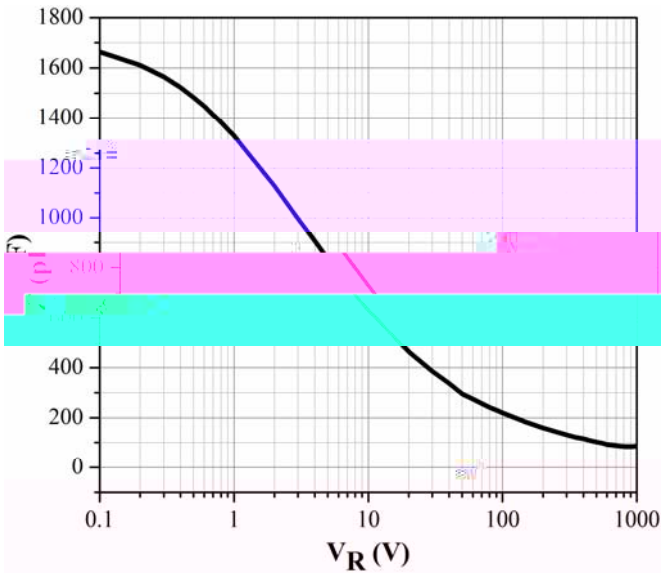



YJD112030NGG3

Outline Dimensions

TO-247AC

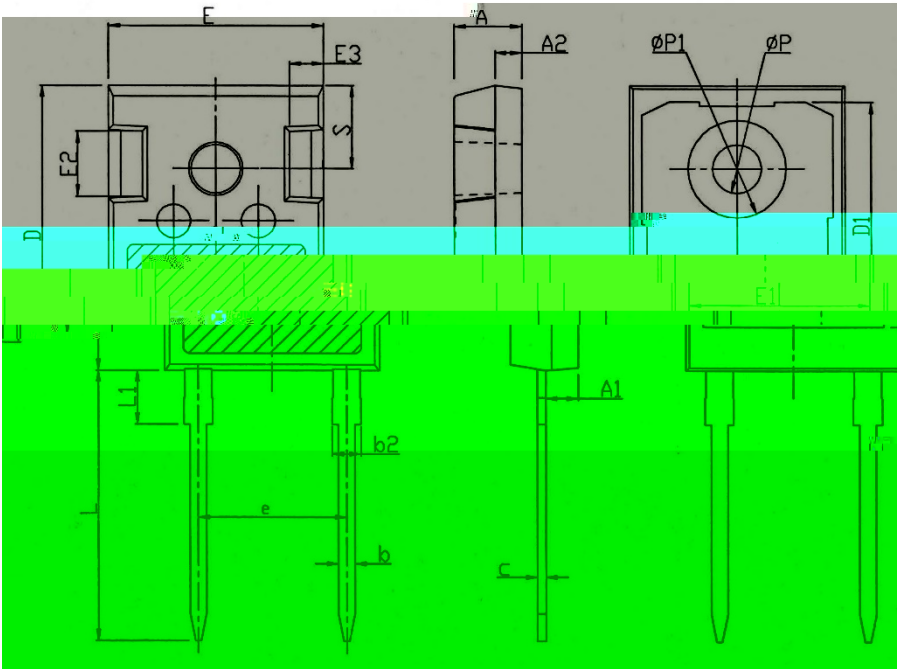

TO-247AC		
=		
:	-)	+)
:	++	+
:	+	+
		.
+		++
)) 0
=	+) 0)	+ .)
=	+	
))
	.))	.)
+	-)	+))
.	+ .)	+ 0)
)	
	+	+) ++
	&	- .)
Φ	. -)	.)
Φ	&	0 .)



Disclaimer

&

3(_____

(