



---

---

---

## 一级代理商：

深圳市弗瑞鑫电子有限公司

地址：深圳市宝安区西乡大道302号金源商务大厦B座三楼

frxelec

%"

:  
:

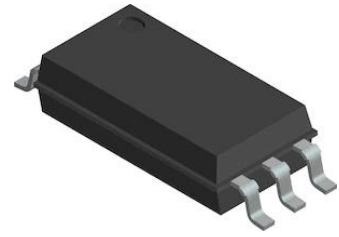

&"

"

("

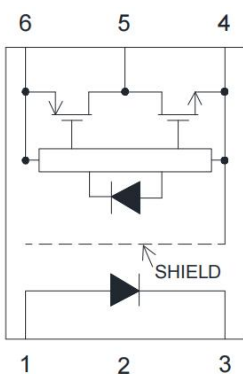

- 1. Anode
- 3. Cathode
- 4. GND
- 5. Vo (Output)
- 6. Vcc

)"

		~	
		~	



"  
,

- "

%"\$"

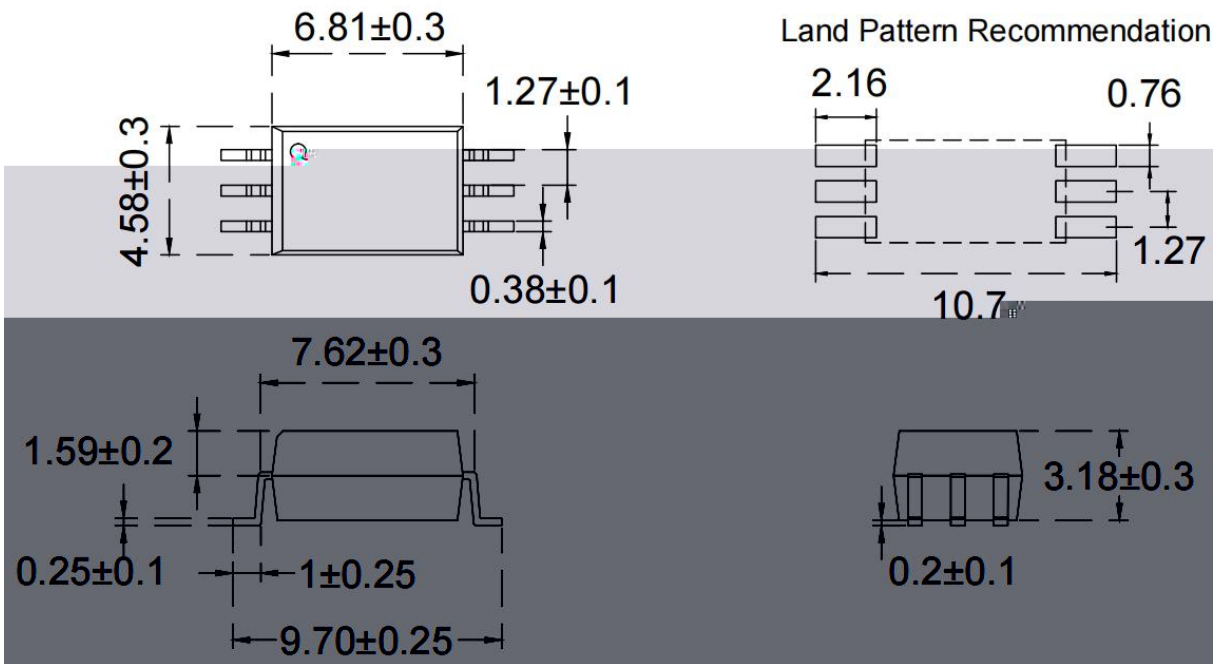
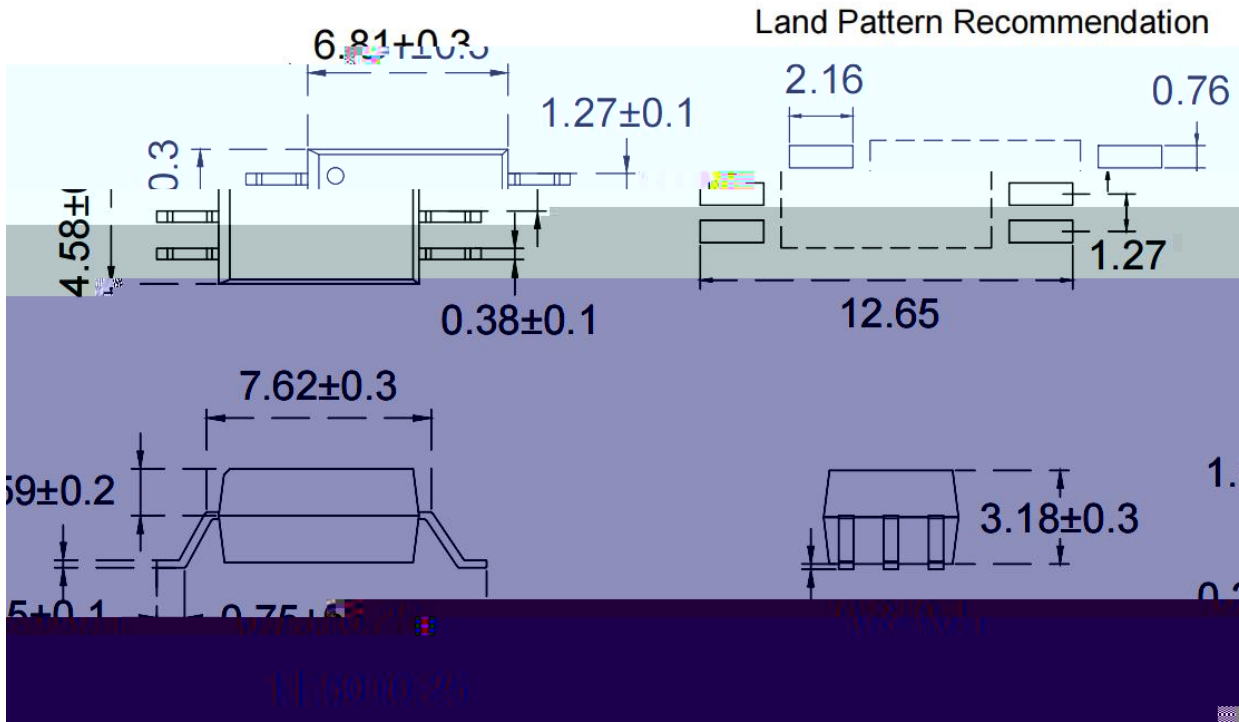

%%"

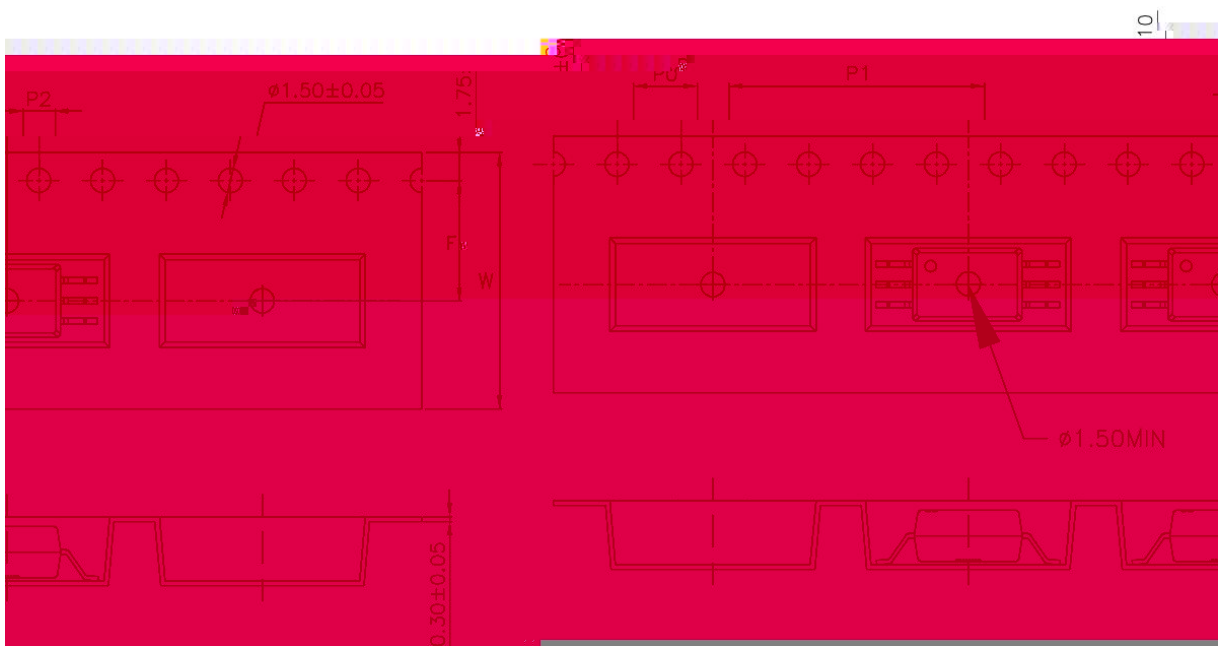
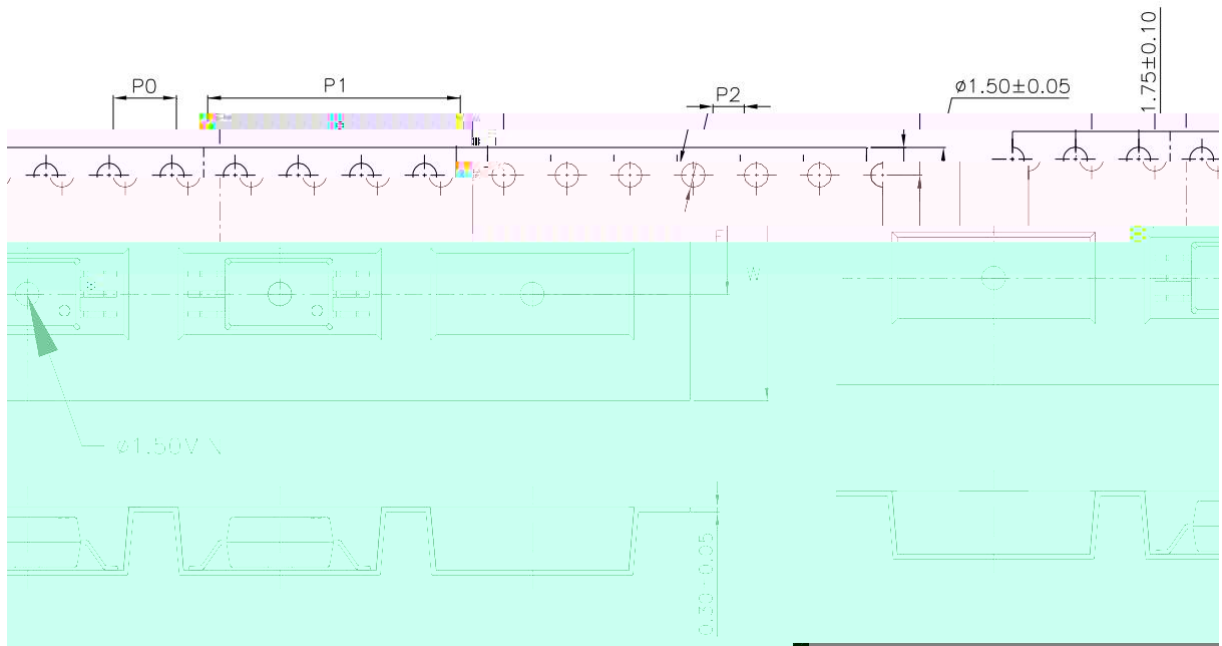



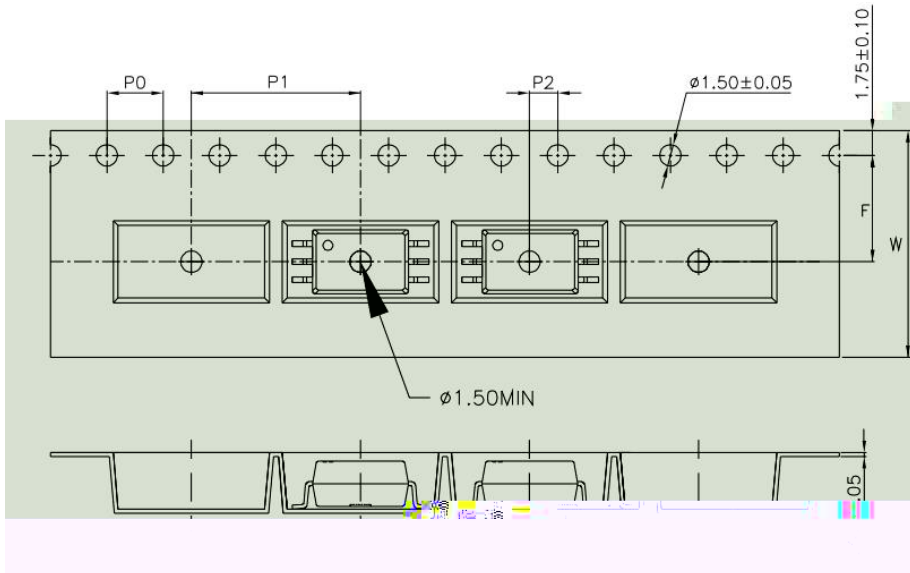
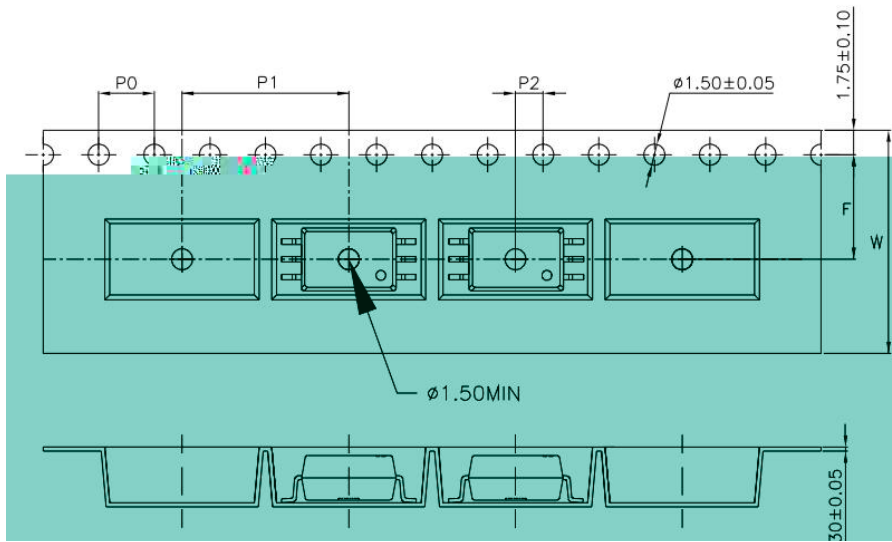





( )	

%&"

**ORIENT**  
ShenZhen Orient  
Components Co.,LTD

Material Code : J20PCXXXXXX

|||||

P/N : OR-XXXXXX

|||||

Lot No. : XXXXXX-XXXX-TX-X

|||||

D/C : XXXX

|||||

Qty : XXXX PCS

|||||

内箱码

外箱码

“XXXXXXXXXXXXXXXXXX” (一体机序列码)

**Made in China**

:





Temperature  
Time

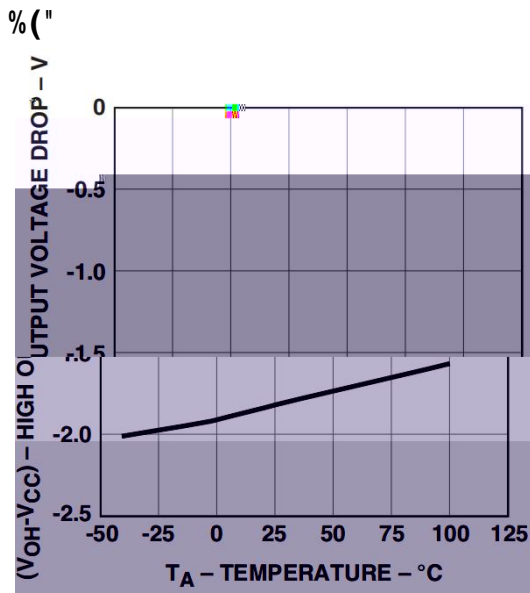

Figure 1.  $V_{OH}$  vs. Temperature.

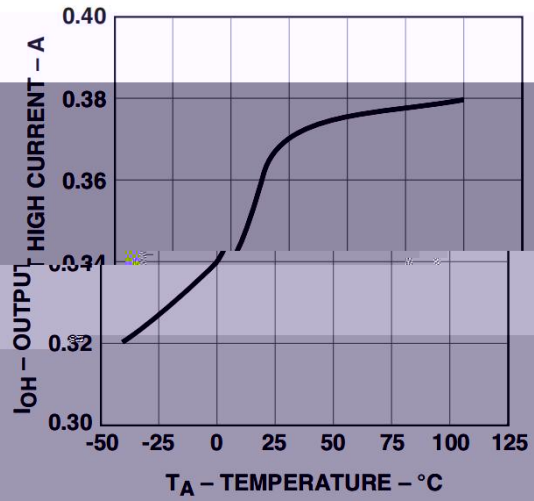
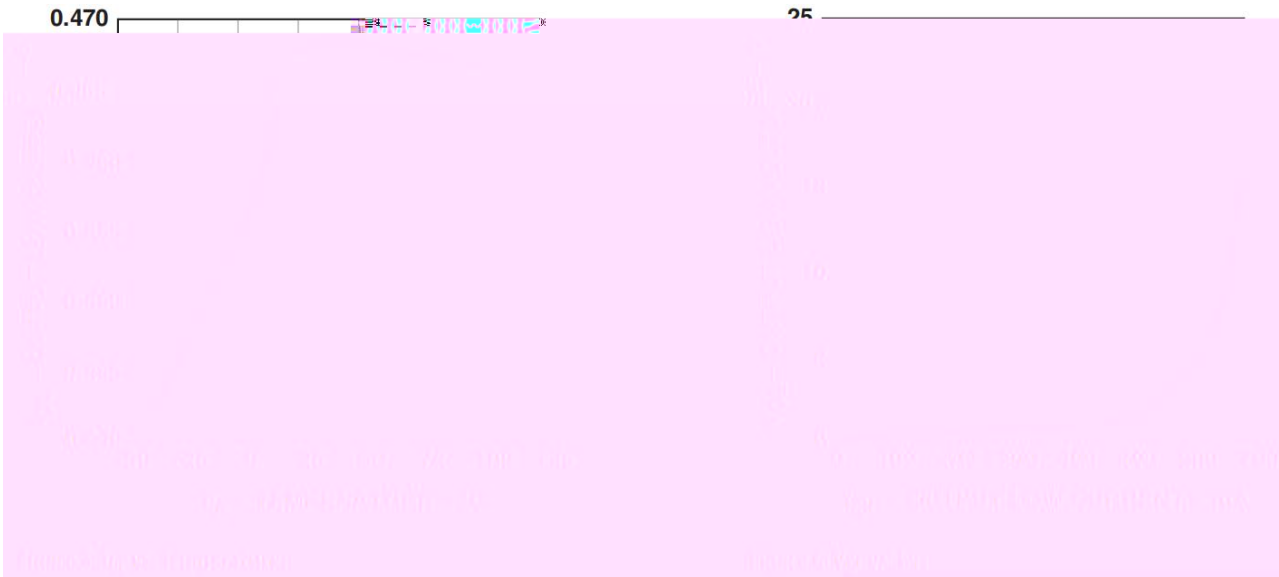
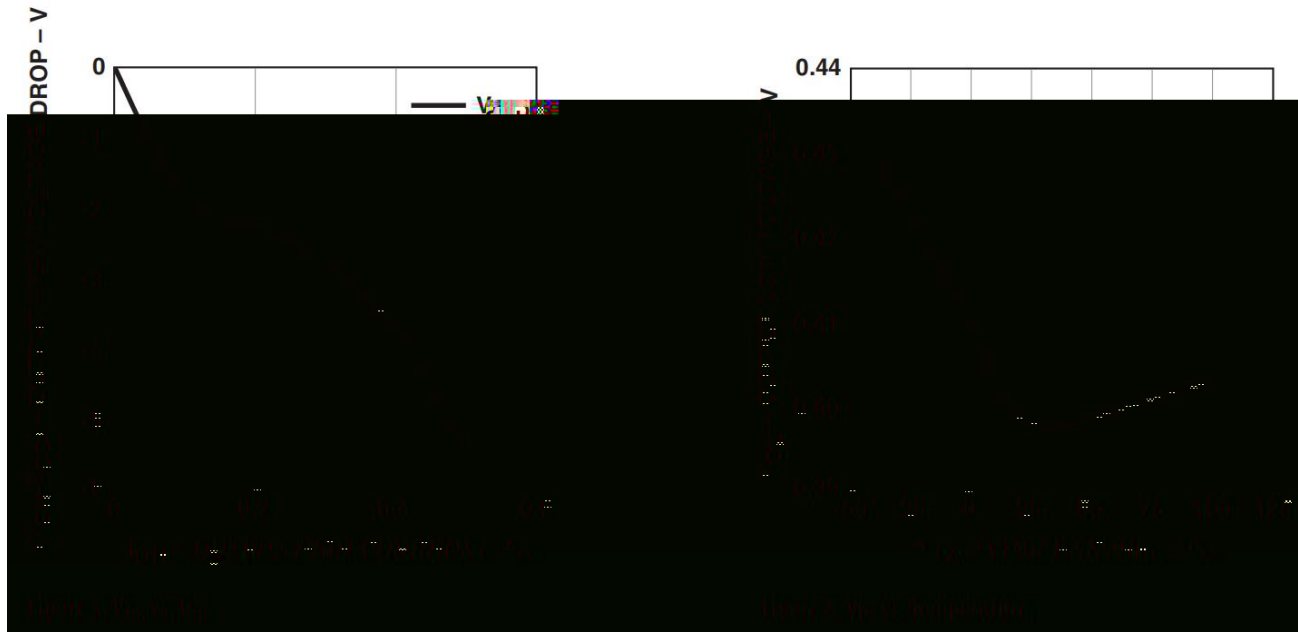

Figure 2.  $I_{OH}$  vs. Temperature.



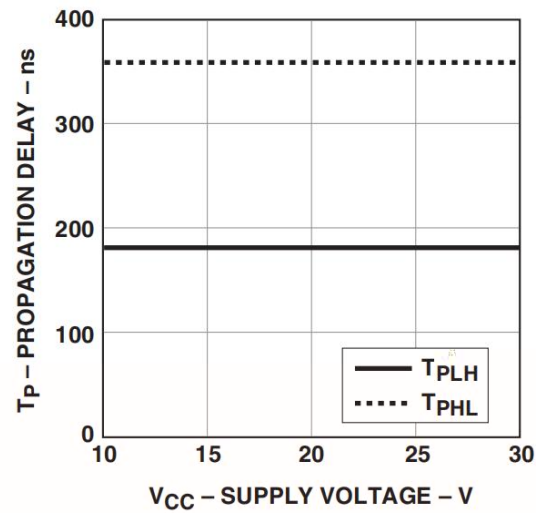
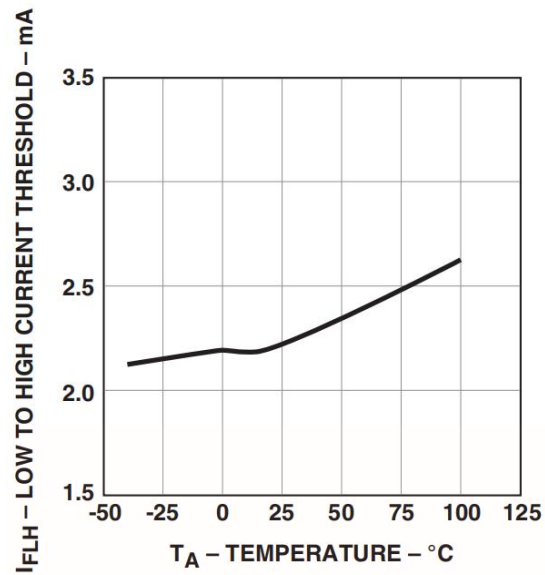
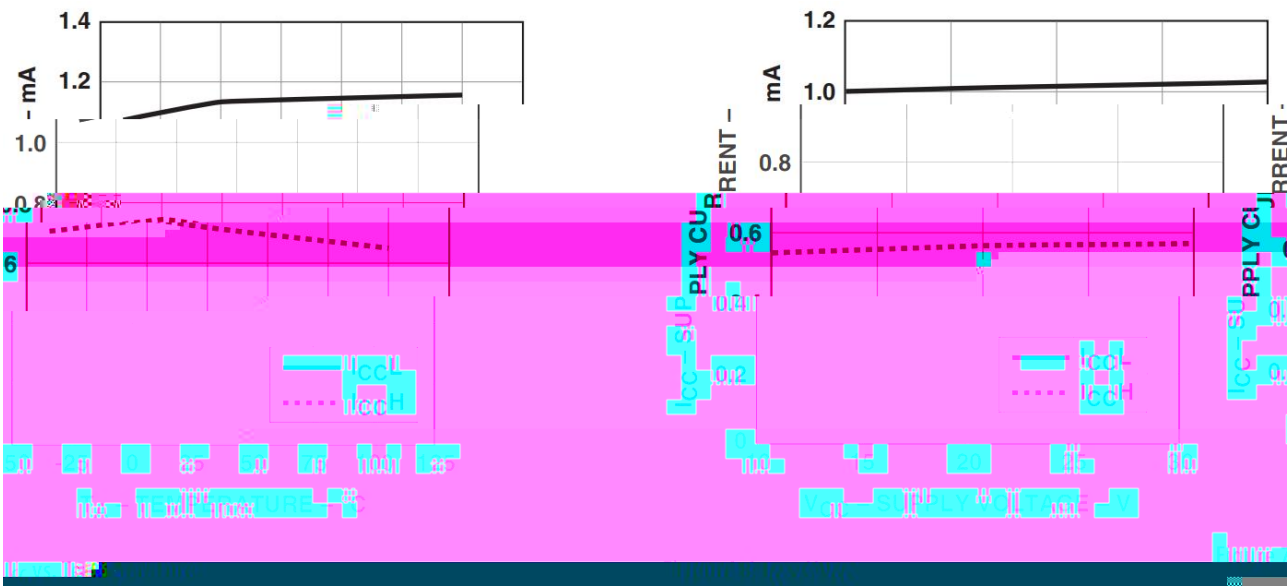
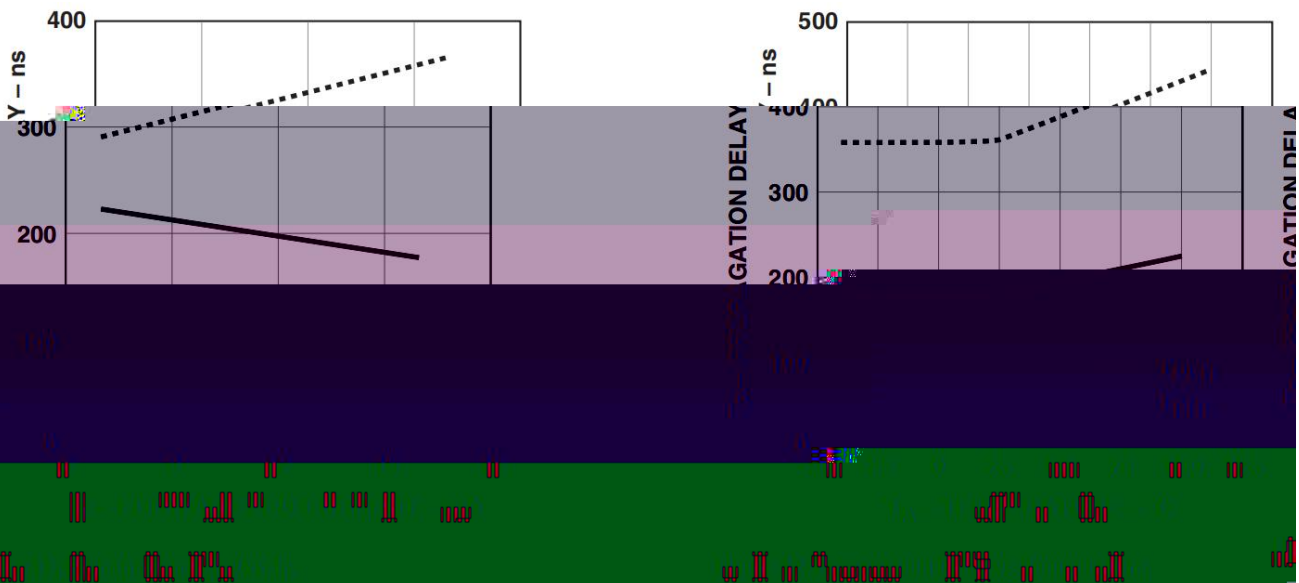

Figure 9.  $I_{FLH}$  vs. Temperature.

Figure 10. Propagation Delay vs.  $V_{CC}$ .



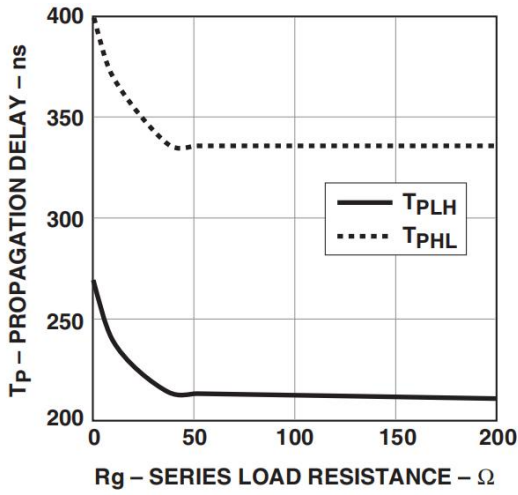

Figure 13. Propagation Delay vs Rg

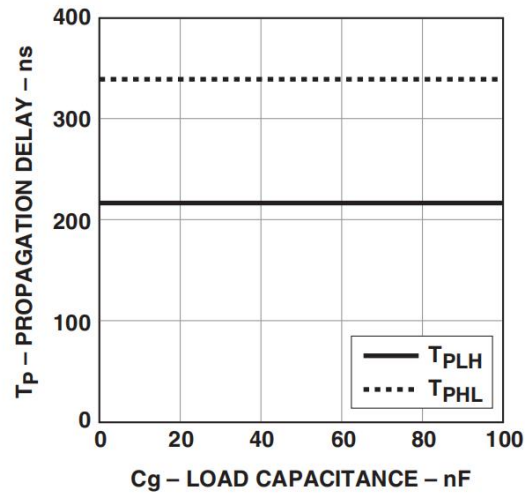

Figure 14. Propagation Delay vs Cg

