



TRX 特锐祥
专 注 电 容 器 廿 年

	SMD- 1 SMD 1 . .		
	/N		/D
	/E		/P



SMD- 1
SMD 1 . .

/N		/D	
/E		/P	

1. /P N

T G 1 102 K

2. /P





SMD- 1
SMD 1 . .

/N

Yf 1

 TRX 专注电容器廿年	SMD- 1		
	SMD 1 . .		
	/N		/D
/E		/P	

/

/

7. /P



SMD- 1			
SMD 1 . .			
/N		/D	
/E		/P	

			<table border="1" style="width: 100%; border-collapse: collapse;"> <tr> <td style="width: 15%;"> </td> <td style="width: 15%;"> </td> <td style="width: 15%;"> </td> <td style="width: 15%;"> </td> <td style="width: 15%;"> </td> <td style="width: 15%;"> </td> </tr> <tr> <td> </td> <td> </td> <td> </td> <td> </td> <td> </td> <td> </td> </tr> </table>												
			±												



SMD- 1
SMD 1 . .

/N

/D

/E

/P

				±	



TRX

专注电容器廿年

SMD- 1

SMD 1 . .

/N

/D

/E

/P

 TRX 专注电容器廿年	SMD- 1 SMD 1 . .		
	/N		/D
	/E		/P

			± ±
			± ±
			± ±
			± ±
			± ±
			± ±
			± ±
			± ±
			± ±

8. /C

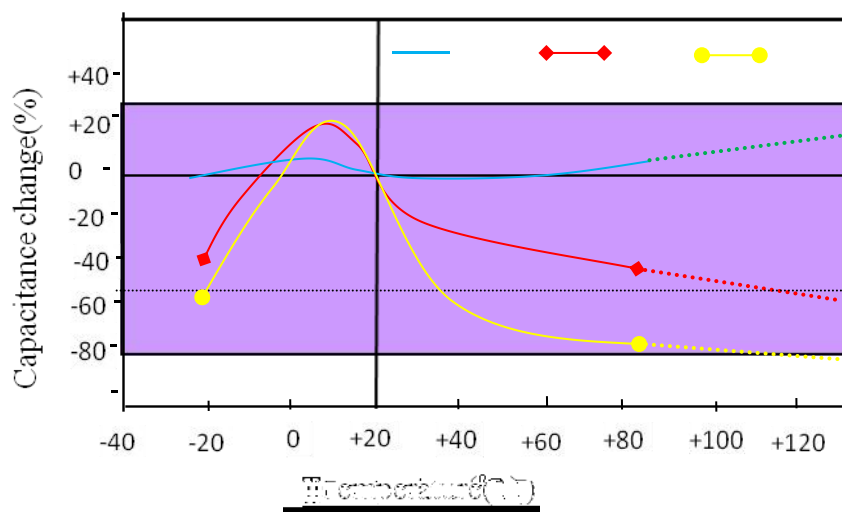



SMD- 1

SMD 1 . .

/N

/D

/E

/P

R HS H.F.
REACH

10. /S

/

/

×

/N

/D

/E

/P

11. /P

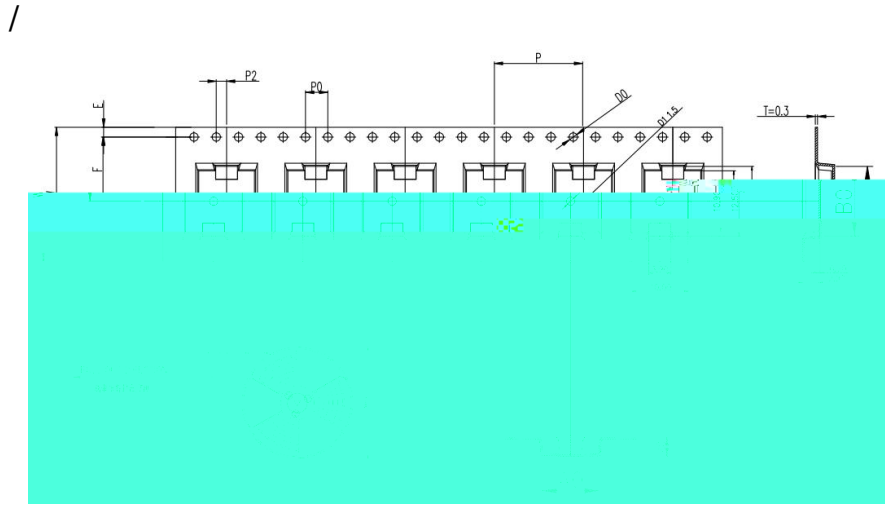

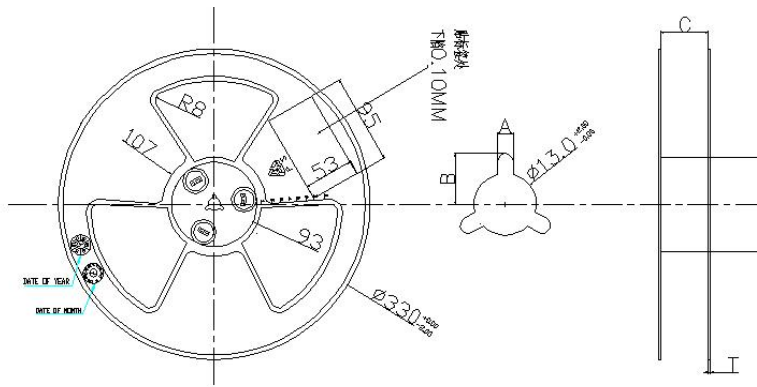

ITEM	W	A0	B0	K1	K0	P	F	E	D0	D1	P0	P2	T
DIM	24.0	$^{+0.30}_{-0.30}$	$^{+0.10}_{-0.10}$	$^{+0.10}_{-0.10}$	$^{+0.10}_{-0.10}$	$^{+0.10}_{-0.10}$	$^{+0.10}_{-0.10}$	$^{+0.10}_{-0.10}$	$^{+0.10}_{-0.00}$	$^{+0.10}_{-0.00}$	$^{+0.10}_{-0.10}$	$^{+0.10}_{-0.10}$	$^{+0.05}_{-0.05}$
ALTERNATE													

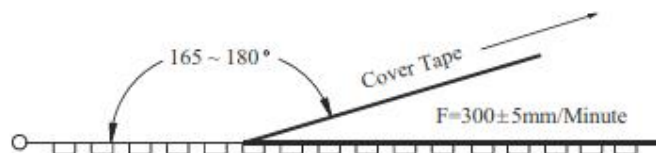

SPEC	A±0.3	B±0.5	C $^{+0.5}_{-0.0}$	D±0.5	T±0.2
24	2.3	10.75	24.4	Ø97	2.2

Item	Data	Remark
Cover tape adhesion	10 ~ 100g	Carrier tape and cover tape open angle 165 ~ 180° F=300± 5mm/minute



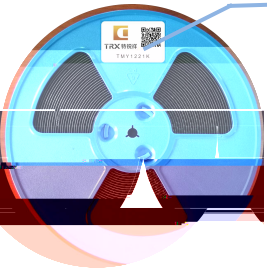

 TRX 专注电容器廿年	SMD- 1 SMD 1 . .		
	/N		/D
	/E		/P

/ -



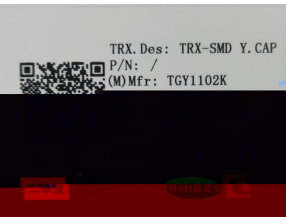





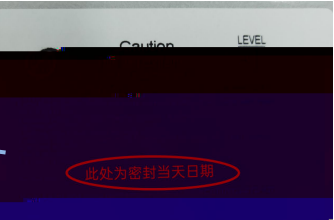

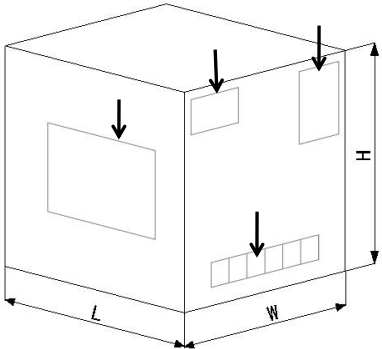

/O -









/
/
/

/P :









/
/

" "

R

