

\_\_\_\_\_

\_\_\_\_\_

\_\_\_\_\_

\_\_\_\_\_





**TRX 特锐祥**  
专注电容器廿年





	<b>SMD- 1</b> <b>SMD 1 . .</b>		
	/N		/D
	/E		/P









/N

SMD- 1  
SMD 1 . .



 <b>TRX</b> 专注电容器廿年	<b>SMD- 1</b>		
	<b>SMD 1 . .</b>		
	/N		/D
/E		/P	

/

/

**7. /P**





SMD- 1  
SMD 1 . .

/N

/D

/E

/P

±





 <b>TRX</b> 专注电容器廿年	<b>SMD- 1</b>		
	<b>SMD 1 . .</b>		
	/N		/D
/E		/P	

			± ±
			± ±
			± ±
			± ±
			± ±
			± ±
			± ±
			± ±
			± ±

8. /C

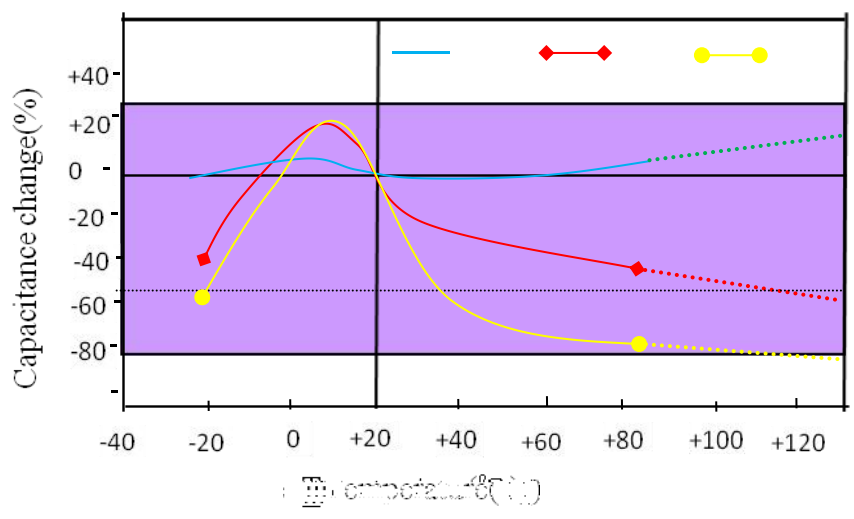



11. /P

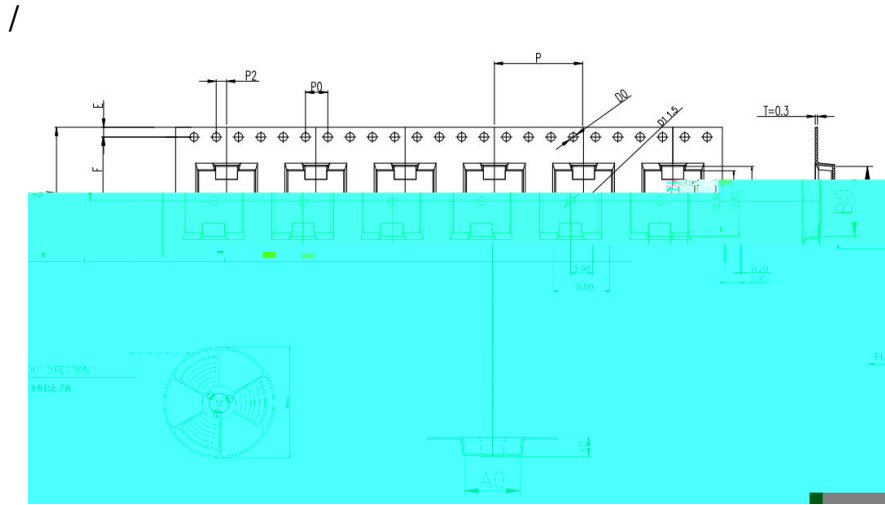

ITEM	W	A0	B0	K1	K0	P	F	E	D0	D1	P0	P2	T
DIM	24.0	$\begin{smallmatrix} +0.30 \\ -0.30 \end{smallmatrix}$	$\begin{smallmatrix} +0.10 \\ -0.10 \end{smallmatrix}$	$\begin{smallmatrix} +0.10 \\ -0.10 \end{smallmatrix}$	$\begin{smallmatrix} +0.10 \\ -0.10 \end{smallmatrix}$	$\begin{smallmatrix} +0.10 \\ -0.10 \end{smallmatrix}$	$\begin{smallmatrix} +0.10 \\ -0.10 \end{smallmatrix}$	$\begin{smallmatrix} +0.10 \\ -0.10 \end{smallmatrix}$	$\begin{smallmatrix} +0.10 \\ -0.10 \end{smallmatrix}$	$\begin{smallmatrix} +0.10 \\ -0.10 \end{smallmatrix}$	$\begin{smallmatrix} +0.10 \\ -0.10 \end{smallmatrix}$	$\begin{smallmatrix} +0.10 \\ -0.10 \end{smallmatrix}$	$\begin{smallmatrix} +0.05 \\ -0.05 \end{smallmatrix}$
ALTERNATE													

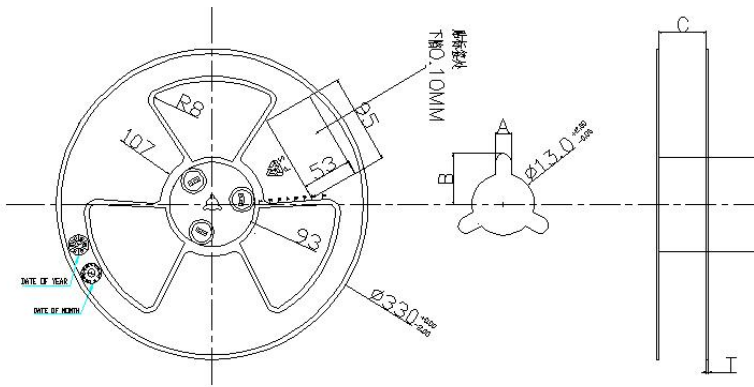

SPEC	A±0.3	B±0.5	C $\begin{smallmatrix} +0.5 \\ -0.0 \end{smallmatrix}$	D±0.5	T±0.2
24	2.3	10.75	24.4	Ø97	2.2

Item	Data	Remark
Cover tape adhesion	10 ~ 100g	Carrier tape and cover tape open angle 165 ~ 180° F=300± 5mm/minute

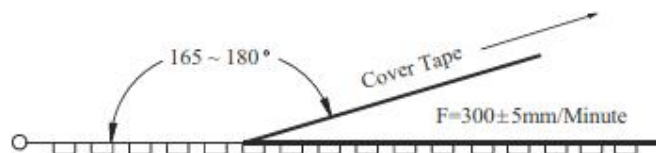



 <b>TRX</b> 专注电容器廿年	<b>SMD- 1</b> <b>SMD 1 . .</b>		
	/N		/D
	/E		/P

/ -





TRX 特锐祥  
TGY1102K







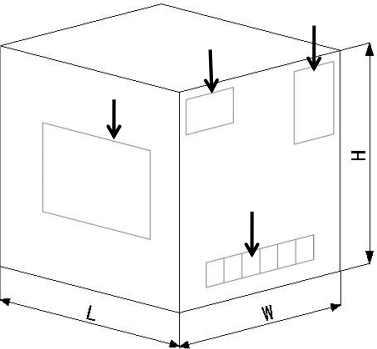

/O -











/
/
/

/P :









/
/

" "

R

